

PE284T-25-4-ODP

GENERAL PURPOSE ELECTRIC MOTOR
NEMA PREMIUM EFFICIENCY
CAST IRON CONSTRUCTION - OPEN DRIP PROOF
INVERTER DUTY 10:1 CT; 20:1 VT - NEMA MG1 PART 31

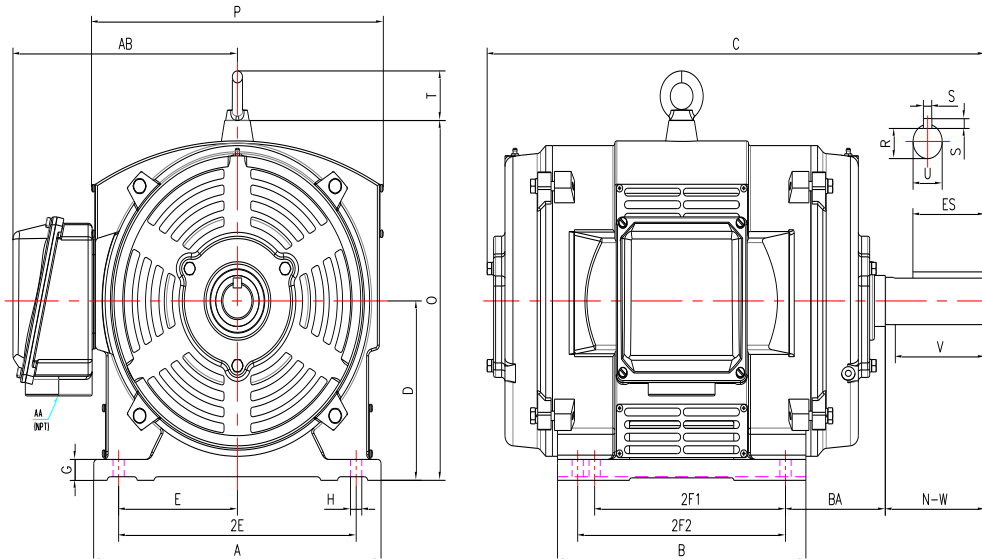

DIMENSIONS

HP	RPM	Frame	MOUNTING														
			A	B	C	D	G	H	J	E	2E	2F1	2F2	O	P	T	BA
25	1800	284T	13.00	12.80	24.80	7.00	0.70	0.53	NA	5.50	11.00	9.50	11.00	14.30	13.95	2.20	4.75

Shaft Extension, Key Set						Conduit Box		Bearings		Mount
U	V	R	S	ES	N-W	AA	AB	DE	ODE	
1.88	4.38	1.59	0.50	3.28	4.62	1.50	10.10	6311	6311	F1

BEARING LUBRICATION: The bearings come lubricated with Mobil Polyrex EM Polyurea Grease. It is recommended that you add some additional lubrication when the motor is installed.

Three options (brands) for suitable lubrication include, but are not limited to, the following:

- 1.) Mobil Polyrex EM
- 2.) Citco Polyurea MP
- 3.) Conoco Phillips Polytac EP





PE284T-25-4-ODP

GENERAL PURPOSE ELECTRIC MOTOR

NEMA PREMIUM EFFICIENCY

CAST IRON CONSTRUCTION - OPEN DRIP PROOF







INVERTER DUTY 10:1 CT; 20:1 VT - NEMA MG1 PART 31

PERFORMANCE DATA

HP	RPM	Frame	Voltage	Frequency (Hz)	Full Load S.F.	Insulation Class	NEMA Design	Slip (%)	NEMA Code	Enclosure Type	IP Rating	Max. Ambient
25	1775	284T	208-230/460	60	1.15	F	B	1.39	G	ODP	23	40° C

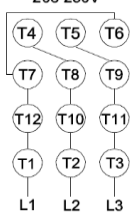
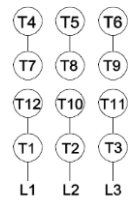
Amps (460V)		Efficiency (%)				Power Factor			Torque (ft-lb)			DE Bearing	ODE Bearing	Connection	Weight (lbs.)
FLA	LRA	100%	75%	50%	Min.	100%	75%	50%	FLT	LRT %	BDT %	6311	6311	12 Lead 2Δ/Δ	378
30.0	182.0	93.6	93.6	92.5	92.4	0.85	0.83	0.75	74.3	160	250				

NAME PLATE

 North American Electric, Inc.															CONNECTION DIAGRAMS 208-230V 		
INVERTER DUTY 20:1 VT; 10:1 CT																	
CAT NO: PE284T-25-4-ODP				FRAME 284T				PHASE 3				460V 					
HZ 60		S.F. 1.15		HZ 50		S.F. 1.0		ENCL ODP		IP 23							
HP 25		RPM 1775		HP 25		RPM 1465		DUTY CONT		DES B							
VOLTS 208-230/460				VOLTS 190/380				AMB 40° C				INS F					
FLA 66 - 60 / 30				FLA 72/36				DE BEARING 6311									
CODE G		P.F. 0.85		CODE F		P.F. 0.86		ODE BEARING 6311									
EFF 93.6		MIN 92.4		EFF 92.3		MIN 91.1		LUB: Mobil Polyrex EM									
MOTOR WEIGHT 378 LBS			CONNECTION 12 Lead 2Δ/Δ				SER NO										
General purpose use on industrial machinery installed in environments with minimal dirt and moisture. Hernando, Mississippi										  		CC 082A					

APPLICATIONS:

General purpose use on pumps, fans, blowers, compressors, conveyors, material handling and other industrial machinery installed in environments with minimal dirt and moisture.