

PE184T-5-4-ODP

GENERAL PURPOSE ELECTRIC MOTOR
 NEMA PREMIUM EFFICIENCY
 ROLLED STEEL CONSTRUCTION - OPEN DRIP PROOF
 INVERTER DUTY 10:1 CT; 20:1 VT - NEMA MG1 PART 31

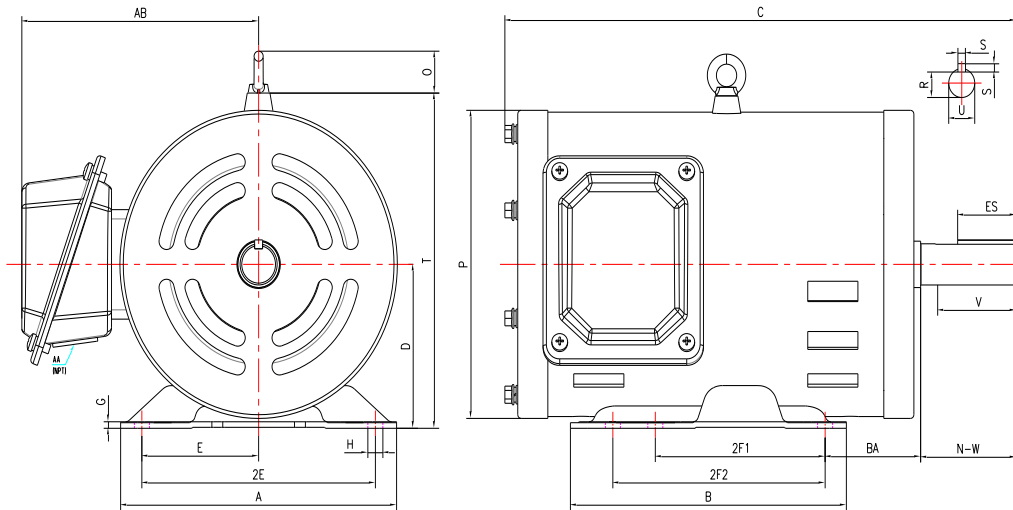

DIMENSIONS

HP	RPM	Frame	MOUNTING														
			A	B	C	D	G	H	J	E	2E	2F1	2F2	O	P	T	BA
5	1800	184T	8.82	6.50	14.90	4.50	0.12	0.71*0.47	NA	3.75	7.50	4.50	5.50	9.50	8.55	1.60	2.75

Shaft Extension, Key Set						Conduit Box		Bearings		Mount
U	V	R	S	ES	N-W	AA	AB	DE	ODE	
1.13	2.50	0.99	0.25	1.78	2.75	0.86	7.00	6206-ZZ	6206-ZZ	F1

BEARING LUBRICATION: The bearings come lubricated with Mobil Polyrex EM Polyurea Grease.





PE184T-5-4-ODP





GENERAL PURPOSE ELECTRIC MOTOR
NEMA PREMIUM EFFICIENCY
ROLLED STEEL CONSTRUCTION - OPEN DRIP PROOF
INVERTER DUTY 10:1 CT; 20:1 VT - NEMA MG1 PART 31

PERFORMANCE DATA

HP	RPM	Frame	Voltage	Frequency (Hz)	Full Load S.F.	Insulation Class	NEMA Design	Slip (%)	NEMA Code	Enclosure Type	IP Rating	Max. Ambient
5	1770	184T	208-230/460	60	1.15	F	B	1.67	J	ODP	23	40° C

Amps (460V)		Efficiency (%)				Power Factor			Torque (ft-lb)			DE Bearing	ODE Bearing	Connection	Weight (lbs.)
FLA	LRA	100%	75%	50%	Min.	100%	75%	50%	FLT	LRT %	BDT %				
6.7	46.0	89.5	89.8	89.0	87.5	0.790	0.740	0.620	15.0	190	280	6206-ZZ	6206-ZZ	9 Lead 2Y/Y	98

NAME PLATE

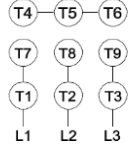
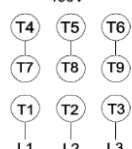
 North American Electric, Inc.													CONNECTION DIAGRAMS		
INVERTER DUTY 20:1 VT; 10:1 CT															
CAT NO:		PE184T-5-4-ODP			FRAME		184T		PHASE		3				
HZ	60	S.F.	1.15	HZ	50	S.F.	1.0	ENCL	ODP	IP	23				
HP	5	RPM	1770	HP	5	RPM	1440	DUTY	CONT	DES	B				
VOLTS		208-230/460			VOLTS		190/380			AMB	40° C		INS F		
FLA	14.7 - 13.4 / 6.7		FLA			15.4/7.7			DE BEARING		6206-ZZ				
CODE	J	P.F.	0.79	CODE	G	P.F.	0.84	ODE BEARING		6206-ZZ					
EFF	89.5	MIN	87.5	EFF	87.5	MIN	85.5	LUB:		Mobil Polyrex EM					
MOTOR WEIGHT		98	LBS	CONNECTION		9 Lead 2Y/Y		SER NO							
<small>General purpose use on industrial machinery installed in environments with minimal dirt and moisture.</small> Hernando, Mississippi										  			CC 082A		
						208-230V 									
						460V 									

APPLICATIONS:

General purpose use on pumps, fans, blowers, compressors, conveyors, material handling and other industrial machinery installed in environments with minimal dirt and moisture.