

**PE404T-100-4-ODP**

GENERAL PURPOSE ELECTRIC MOTOR

NEMA PREMIUM EFFICIENCY

CAST IRON CONSTRUCTION - OPEN DRIP PROOF

INVERTER DUTY 10:1 CT; 20:1 VT - NEMA MG1 PART 31

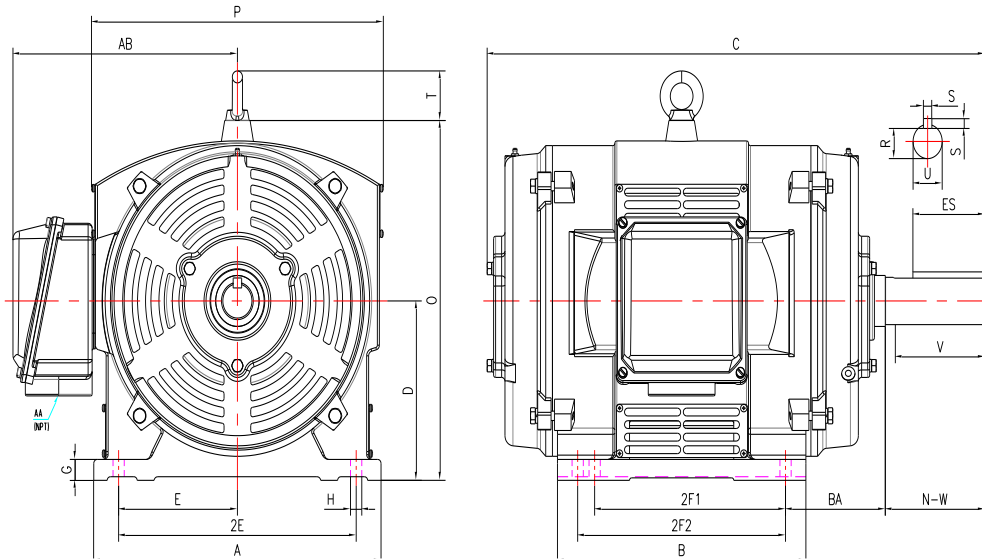

**DIMENSIONS**

HP	RPM	Frame	MOUNTING														
			A	B	C	D	G	H	J	E	2E	2F1	2F2	O	P	T	BA
100	1800	404T	19.10	17.00	33.30	10.00	1.15	0.81	NA	8.00	16.00	12.25	13.75	21.00	20.25	2.60	6.62

Shaft Extension, Key Set						Conduit Box		Bearings		Mount
U	V	R	S	ES	N-W	AA	AB	DE	ODE	
2.88	7.00	2.45	0.75	5.65	7.25	3.00	14.50	NU318	6314	F1

**BEARING LUBRICATION:** The bearings come lubricated with Mobil Polyrex EM Polyurea Grease. It is recommended that you add some additional lubrication when the motor is installed.

Three options (brands) for suitable lubrication include, but are not limited to, the following:

- 1.) Mobil Polyrex EM
- 2.) Citco Polyurea MP
- 3.) Conoco Phillips Polytac EP





## PE404T-100-4-ODP

GENERAL PURPOSE ELECTRIC MOTOR

NEMA PREMIUM EFFICIENCY

CAST IRON CONSTRUCTION - OPEN DRIP PROOF







INVERTER DUTY 10:1 CT; 20:1 VT - NEMA MG1 PART 31

### PERFORMANCE DATA

HP	RPM	Frame	Voltage	Frequency (Hz)	Full Load S.F.	Insulation Class	NEMA Design	Slip (%)	NEMA Code	Enclosure Type	IP Rating	Max. Ambient
100	1785	404T	208-230/460	60	1.15	F	B	0.83	G	ODP	23	40° C

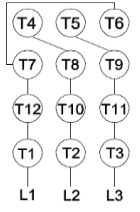
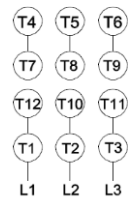
Amps (460V)		Efficiency (%)				Power Factor			Torque (ft-lb)			DE Bearing	ODE Bearing	Connection	Weight (lbs.)
FLA	LRA	100%	75%	50%	Min.	100%	75%	50%	FLT	LRT %	BDT %	NU318	6314	12 Lead 2Δ/Δ	1115
112.0	725.0	95.4	95.0	94.6	94.5	0.87	0.84	0.77	296.0	150	240				

### NAME PLATE

 <b>North American Electric, Inc.</b>															<b>CONNECTION DIAGRAMS</b> <b>208-230V</b> 		
<b>INVERTER DUTY 20:1 VT; 10:1 CT</b>																	
CAT NO: PE404T-100-4-ODP			FRAME 404T				PHASE 3										
HZ 60		S.F. 1.15		HZ 50		S.F. 1.0		ENCL ODP		IP 23							
HP 100		RPM 1785		HP 100		RPM 1485		DUTY CONT		DES B							
VOLTS 208-230/460			VOLTS 190/380			AMB 40° C			INS F								
FLA 246 - 224 / 112		FLA 274/137			DE BEARING NU318												
CODE G		P.F. 0.87		CODE D		P.F. 0.88		ODE BEARING 6314									
EFF 95.4		MIN 94.5		EFF 94.1		MIN 93.2		LUB: Mobil Polyrex EM									
MOTOR WEIGHT 1115 LBS		CONNECTION 12 Lead 2Δ/Δ			SER NO						<b>460V</b> 						
General purpose use on industrial machinery installed in environments with minimal dirt and moisture. Hernando, Mississippi																CC 082A	

### APPLICATIONS:

General purpose use on pumps, fans, blowers, compressors, conveyors, material handling and other industrial machinery installed in environments with minimal dirt and moisture.