

PE324T-40-4-ODP

GENERAL PURPOSE ELECTRIC MOTOR

NEMA PREMIUM EFFICIENCY

CAST IRON CONSTRUCTION - OPEN DRIP PROOF

INVERTER DUTY 10:1 CT; 20:1 VT - NEMA MG1 PART 31

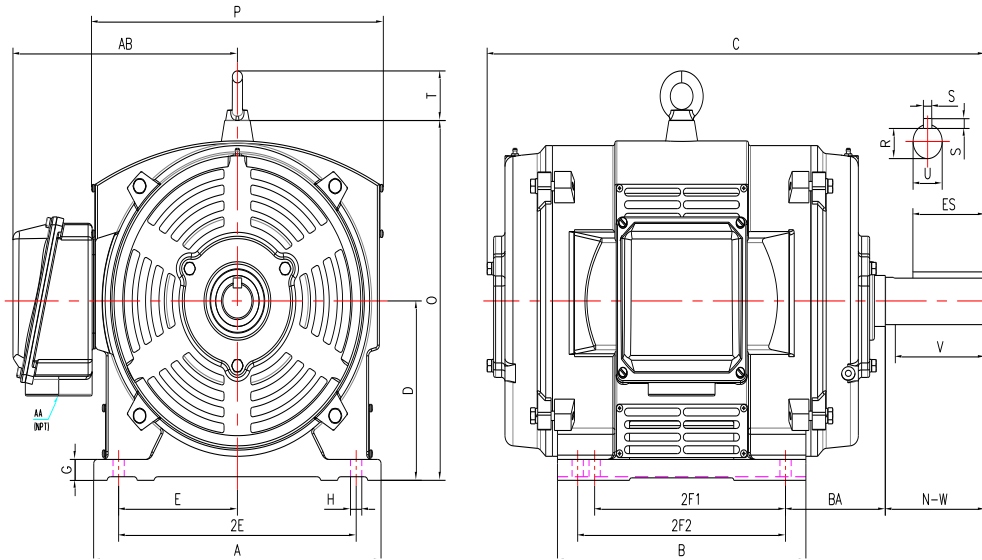

DIMENSIONS

HP	RPM	Frame	MOUNTING														
			A	B	C	D	G	H	J	E	2E	2F1	2F2	O	P	T	BA
40	1800	324T	14.60	13.95	27.10	8.00	0.85	0.66	NA	6.25	12.50	10.50	12.00	16.10	15.35	2.60	5.25

Shaft Extension, Key Set						Conduit Box		Bearings		Mount
U	V	R	S	ES	N-W	AA	AB	DE	ODE	
2.13	5.00	1.85	0.50	3.91	5.25	2.00	11.40	6312	6312	F1

BEARING LUBRICATION: The bearings come lubricated with Mobil Polyrex EM Polyurea Grease. It is recommended that you add some additional lubrication when the motor is installed.

Three options (brands) for suitable lubrication include, but are not limited to, the following:

- 1.) Mobil Polyrex EM
- 2.) Citco Polyurea MP
- 3.) Conoco Phillips Polytac EP





PE324T-40-4-ODP

GENERAL PURPOSE ELECTRIC MOTOR

NEMA PREMIUM EFFICIENCY

CAST IRON CONSTRUCTION - OPEN DRIP PROOF







INVERTER DUTY 10:1 CT; 20:1 VT - NEMA MG1 PART 31

PERFORMANCE DATA

HP	RPM	Frame	Voltage	Frequency (Hz)	Full Load S.F.	Insulation Class	NEMA Design	Slip (%)	NEMA Code	Enclosure Type	IP Rating	Max. Ambient
40	1780	324T	208-230/460	60	1.15	F	B	1.11	G	ODP	23	40° C

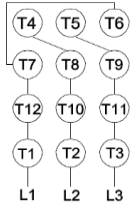
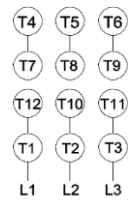
Amps (460V)		Efficiency (%)				Power Factor			Torque (ft-lb)			DE Bearing	ODE Bearing	Connection	Weight (lbs.)
FLA	LRA	100%	75%	50%	Min.	100%	75%	50%	FLT	LRT %	BDT %				
48.0	290.0	94.1	94.0	93.6	93.0	0.83	0.79	0.70	118.8	170	250	6312	6312	12 Lead 2Δ/Δ	521

NAME PLATE

 North American Electric, Inc.													CONNECTION DIAGRAMS 208-230V 		
INVERTER DUTY 20:1 VT; 10:1 CT															
CAT NO: PE324T-40-4-ODP			FRAME 324T				PHASE 3								
HZ 60		S.F. 1.15		HZ 50		S.F. 1.0		ENCL ODP		IP 23					
HP 40		RPM 1780		HP 40		RPM 1470		DUTY CONT		DES B					
VOLTS 208-230/460			VOLTS 190/380			AMB 40° C			INS F						
FLA 106 - 96 / 48		FLA 115/58			DE BEARING 6312										
CODE G		P.F. 0.83		CODE D		P.F. 0.85		ODE BEARING 6312							
EFF 94.1		MIN 93.0		EFF 92.8		MIN 91.5		LUB: Mobil Polyrex EM							
MOTOR WEIGHT 521 LBS		CONNECTION 12 Lead 2Δ/Δ			SER NO						460V 				
General purpose use on industrial machinery installed in environments with minimal dirt and moisture. Hernando, Mississippi										   CC 082A					

APPLICATIONS:

General purpose use on pumps, fans, blowers, compressors, conveyors, material handling and other industrial machinery installed in environments with minimal dirt and moisture.