

PE213T-10-2-ODP

GENERAL PURPOSE ELECTRIC MOTOR
NEMA PREMIUM EFFICIENCY
ROLLED STEEL CONSTRUCTION - OPEN DRIP PROOF
INVERTER DUTY 10:1 CT; 20:1 VT - NEMA MG1 PART 31

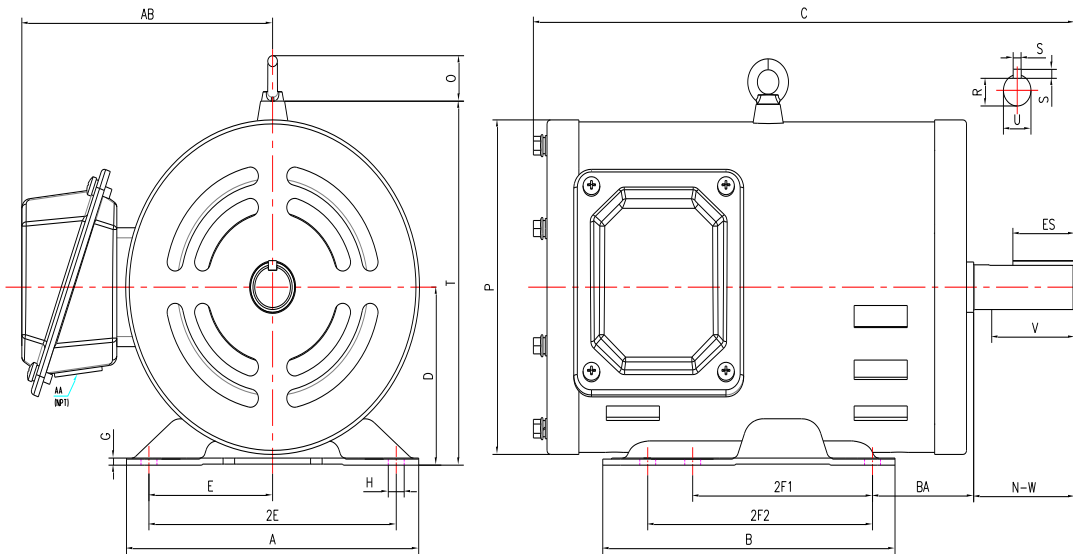

DIMENSIONS

HP	RPM	Frame	MOUNTING														
			A	B	C	D	G	H	J	E	2E	2F1	2F2	O	P	T	BA
10	3600	213T	9.53	8.03	16.54	5.25	0.16	0.43	NA	4.25	8.50	5.50	7.00	11.20	10.10	1.70	3.50

Shaft Extension, Key Set						Conduit Box		Bearings		Mount
U	V	R	S	ES	N-W	AA	AB	DE	ODE	
1.38	3.12	1.20	0.31	2.41	3.38	0.86	7.80	6208-ZZ	6208-ZZ	F1

BEARING LUBRICATION: The bearings come lubricated with Mobil Polyrex EM Polyurea Grease.





PE213T-10-2-ODP







GENERAL PURPOSE ELECTRIC MOTOR
 NEMA PREMIUM EFFICIENCY
 ROLLED STEEL CONSTRUCTION - OPEN DRIP PROOF
 INVERTER DUTY 10:1 CT; 20:1 VT - NEMA MG1 PART 31

PERFORMANCE DATA

HP	RPM	Frame	Voltage	Frequency (Hz)	Full Load S.F.	Insulation Class	NEMA Design	Slip (%)	NEMA Code	Enclosure Type	IP Rating	Max. Ambient
10	3545	213T	208-230/460	60	1.15	F	B	1.53	H	ODP	23	40° C

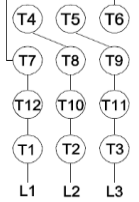
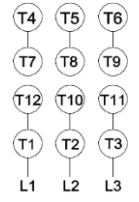
Amps (460V)		Efficiency (%)				Power Factor			Torque (ft-lb)			DE Bearing	ODE Bearing	Connection	Weight (lbs.)
FLA	LRA	100%	75%	50%	Min.	100%	75%	50%	FLT	LRT %	BDT %				
12.8	81.0	89.5	88.5	86.0	87.5	0.910	0.750	0.630	14.9	160	290	6208-ZZ	6208-ZZ	12 Lead 2Δ/Δ	135

NAME PLATE

 North American Electric, Inc.													CONNECTION DIAGRAMS 208-230V 			
INVERTER DUTY 20:1 VT; 10:1 CT																
CAT NO: PE213T-10-2-ODP				FRAME 213T				PHASE 3				460V 				
HZ 60		S.F. 1.15		HZ 50		S.F. 1.0		ENCL ODP		IP 23						
HP 10		RPM 3545		HP 10		RPM 2910		DUTY CONT		DES B						
VOLTS 208-230/460				VOLTS 190/380				AMB 40° C							INS F	
FLA 28.2 - 25.6 / 12.8				FLA 27.4/13.7				DE BEARING 6208-ZZ								
CODE H		P.F. 0.91		CODE E		P.F. 0.93		ODE BEARING 6208-ZZ								
EFF 89.5		MIN 87.5		EFF 87.5		MIN 85.5		LUB: Mobil Polyrex EM								
MOTOR WEIGHT 135 LBS			CONNECTION 12 Lead 2Δ/Δ				SER NO									
General purpose use on industrial machinery installed in environments with minimal dirt and moisture. Hernando, Mississippi										   CC 082A						

APPLICATIONS:

General purpose use on pumps, fans, blowers, compressors, conveyors, material handling and other industrial machinery installed in environments with minimal dirt and moisture.