

PE444TS-200-2-ODP

GENERAL PURPOSE ELECTRIC MOTOR
NEMA PREMIUM EFFICIENCY
CAST IRON CONSTRUCTION - OPEN DRIP PROOF
INVERTER DUTY 10:1 CT; 20:1 VT - NEMA MG1 PART 31

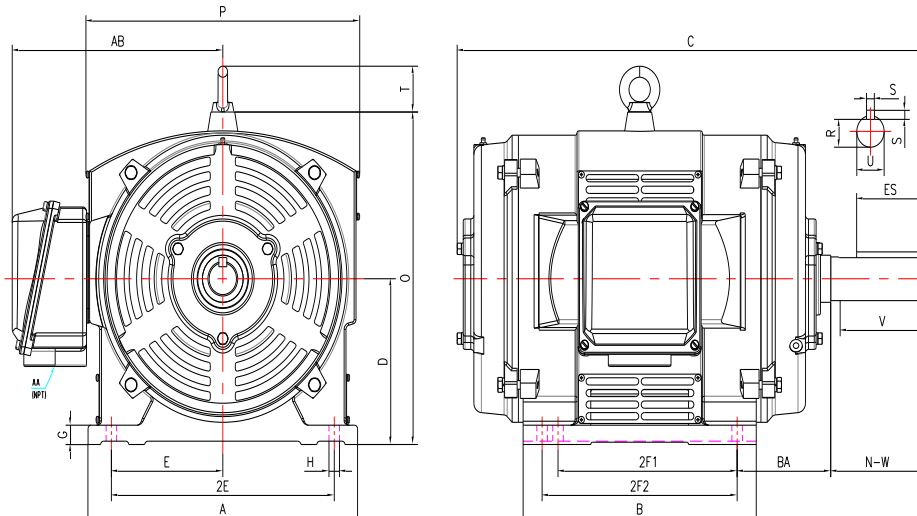

DIMENSIONS

HP	RPM	Frame	MOUNTING														
			A	B	C	D	G	H	J	E	2E	2F1	2F2	O	P	T	BA
200	3600	444TS	22.30	20.80	34.75	11.00	1.15	0.81	NA	9.00	18.00	14.50	16.50	22.60	23.30	3.00	7.50

Shaft Extension, Key Set						Conduit Box		Bearings		Mount
U	V	R	S	ES	N-W	AA	AB	DE	ODE	
2.38	4.50	2.02	0.63	3.03	4.75	3.00	18.90	6314	6314	F1

BEARING LUBRICATION: The bearings come lubricated with Mobil Polyrex EM Polyurea Grease. It is recommended that you add some additional lubrication when the motor is installed.

Three options (brands) for suitable lubrication include, but are not limited to, the following:

- 1.) Mobil Polyrex EM
- 2.) Citco Polyurea MP
- 3.) Conoco Phillips Polytac EP





PE444TS-200-2-ODP







**GENERAL PURPOSE ELECTRIC MOTOR
 NEMA PREMIUM EFFICIENCY
 CAST IRON CONSTRUCTION - OPEN DRIP PROOF
 INVERTER DUTY 10:1 CT; 20:1 VT - NEMA MG1 PART 31**

PERFORMANCE DATA

HP	RPM	Frame	Voltage	Frequency (Hz)	Full Load S.F.	Insulation Class	NEMA Design	Slip (%)	NEMA Code	Enclosure Type	IP Rating	Max. Ambient
200	3575	444TS	460	60	1.15	F	B	0.69	G	ODP	23	40° C

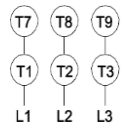
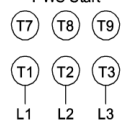
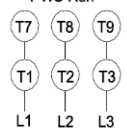
Amps (460V)		Efficiency (%)				Power Factor			Torque (ft-lb)			DE Bearing	ODE Bearing	Connection	Weight (lbs.)
FLA	LRA	100%	75%	50%	Min.	100%	75%	50%	FLT	LRT %	BDT %				
219	1450	95.0	94.4	94.0	94.1	0.90	0.88	0.84	293.9	130	240	6314	6314	6 Lead Δ	1519

NAME PLATE

 										CONNECTION DIAGRAMS (460V)					
INVERTER DUTY 20:1 VT; 10:1 CT										Across The Line 					
CAT NO:		PE444TS-200-2-ODP			FRAME		444TS		PHASE		3		PWS Start 		
HZ	60	S.F.	1.15	HZ	50	S.F.	1.0	ENCL	ODP	IP	23	PWS Run 			
HP	200	RPM	3575	HP	200	RPM	2980	DUTY	CONT	DES	B				
VOLTS		460			VOLTS		380		AMB	40° C		INS	F		
FLA		219.0			FLA		262		DE BEARING			6314			
CODE	G	P.F.	0.90	CODE	F	P.F.	0.92	ODE BEARING			6314				
EFF	95.0	MIN	94.1	EFF	93.5	MIN	92.6	LUB:			Mobil Polyrex EM				
MOTOR WEIGHT		1519 LBS		CONNECTION			6 Lead Δ		SER NO						
General purpose use on industrial machinery installed in environments with minimal dirt and moisture. Hernando, Mississippi										  		CC 082A			

APPLICATIONS:

General purpose use on pumps, fans, blowers, compressors, conveyors, material handling and other industrial machinery installed in environments with minimal dirt and moisture.