

**PE326TS-50-4-ODP**

**GENERAL PURPOSE ELECTRIC MOTOR**  
**NEMA PREMIUM EFFICIENCY**  
**CAST IRON CONSTRUCTION - OPEN DRIP PROOF**  
**INVERTER DUTY 10:1 CT; 20:1 VT - NEMA MG1 PART 31**

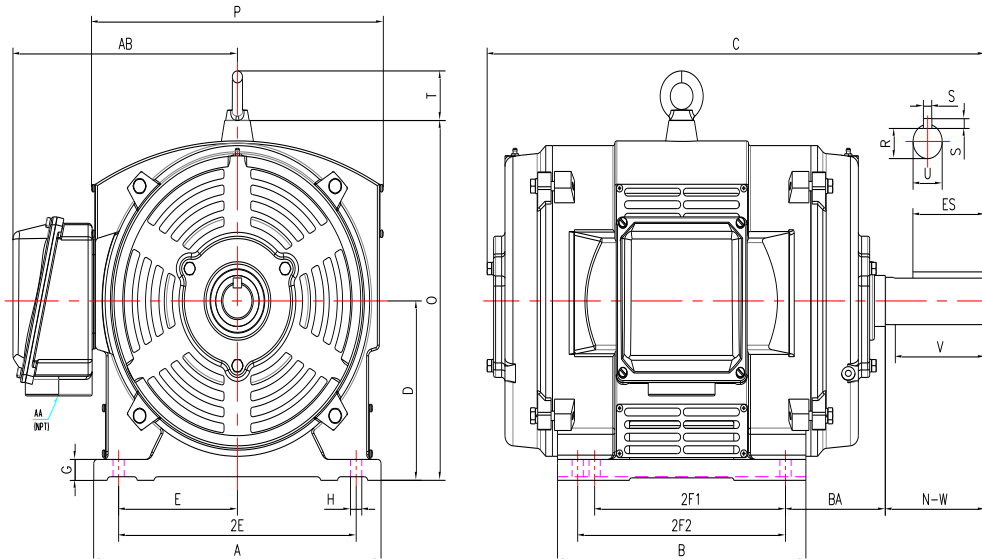

**DIMENSIONS**

| HP | RPM  | Frame | MOUNTING |       |       |      |      |      |    |      |       |       |       |       |       |      |      |
|----|------|-------|----------|-------|-------|------|------|------|----|------|-------|-------|-------|-------|-------|------|------|
|    |      |       | A        | B     | C     | D    | G    | H    | J  | E    | 2E    | 2F1   | 2F2   | O     | P     | T    | BA   |
| 50 | 1800 | 326TS | 14.60    | 13.95 | 25.60 | 8.00 | 0.85 | 0.66 | NA | 6.25 | 12.50 | 10.50 | 12.00 | 16.10 | 15.35 | 2.60 | 5.25 |

| Shaft Extension, Key Set |      |      |      |      |      | Conduit Box |       | Bearings |      | Mount |
|--------------------------|------|------|------|------|------|-------------|-------|----------|------|-------|
| U                        | V    | R    | S    | ES   | N-W  | AA          | AB    | DE       | ODE  |       |
| 1.88                     | 3.50 | 1.59 | 0.50 | 2.03 | 3.75 | 2.00        | 11.40 | 6312     | 6312 | F1    |

**BEARING LUBRICATION:** The bearings come lubricated with Mobil Polyrex EM Polyurea Grease. It is recommended that you add some additional lubrication when the motor is installed.

Three options (brands) for suitable lubrication include, but are not limited to, the following:

- 1.) Mobil Polyrex EM
- 2.) Citco Polyurea MP
- 3.) Conoco Phillips Polytac EP





## PE326TS-50-4-ODP

**GENERAL PURPOSE ELECTRIC MOTOR**

**NEMA PREMIUM EFFICIENCY**

**CAST IRON CONSTRUCTION - OPEN DRIP PROOF**







**INVERTER DUTY 10:1 CT; 20:1 VT - NEMA MG1 PART 31**

### PERFORMANCE DATA

| HP | RPM  | Frame | Voltage     | Frequency (Hz) | Full Load S.F. | Insulation Class | NEMA Design | Slip (%) | NEMA Code | Enclosure Type | IP Rating | Max. Ambient |
|----|------|-------|-------------|----------------|----------------|------------------|-------------|----------|-----------|----------------|-----------|--------------|
| 50 | 1778 | 326TS | 208-230/460 | 60             | 1.15           | F                | B           | 1.22     | G         | ODP            | 23        | 40° C        |

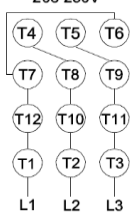
| Amps (460V) |       | Efficiency (%) |      |      |      | Power Factor |      |      | Torque (ft-lb) |       |       | DE Bearing | ODE Bearing | Connection   | Weight (lbs.) |
|-------------|-------|----------------|------|------|------|--------------|------|------|----------------|-------|-------|------------|-------------|--------------|---------------|
| FLA         | LRA   | 100%           | 75%  | 50%  | Min. | 100%         | 75%  | 50%  | FLT            | LRT % | BDT % | 6312       | 6312        | 12 Lead 2Δ/Δ | 569           |
| 59.0        | 362.0 | 94.5           | 94.5 | 94.0 | 93.6 | 0.83         | 0.80 | 0.70 | 148.4          | 170   | 260   |            |             |              |               |

### NAME PLATE

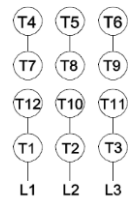
|  |  |                         |             |               |  |                 |         |                       |  |   |  |  |  |  |  |  |  |
|--|--|-------------------------|-------------|---------------|--|-----------------|---------|-----------------------|--|---|--|--|--|--|--|--|--|
|  <b>North American Electric, Inc.</b>       |  |                         |             |               |  |                 |         |                       |  |   |  |  |  |  | <b>CONNECTION DIAGRAMS</b><br><b>208-230V</b><br> |  |  |
| <b>INVERTER DUTY 20:1 VT; 10:1 CT</b>  |  |                         |             |               |  |                 |         |                       |  |   |  |  |  |  |  |  |  |
| CAT NO: PE326TS-50-4-ODP   |  |                         | FRAME 326TS |               |  |                 | PHASE 3 |                       |  |   |  |  |  |  |  |  |  |
| HZ 60  |  | S.F. 1.15               |             | HZ 50         |  | S.F. 1.0        |         | ENCL ODP              |  | IP 23   |  |  |  |  |  |  |  |
| HP 50  |  | RPM 1778                |             | HP 50         |  | RPM 1475        |         | DUTY CONT             |  | DES B   |  |  |  |  |  |  |  |
| VOLTS 208-230/460  |  |                         |             | VOLTS 190/380 |  |                 |         | AMB 40° C             |  | INS F   |  |  |  |  |  |  |  |
| FLA 130 - 118 / 59   |  | FLA 143/72              |             |               |  | DE BEARING 6312 |         |                       |  |   |  |  |  |  |  |  |  |
| CODE G   |  | P.F. 0.83               |             | CODE D        |  | P.F. 0.85       |         | ODE BEARING 6312      |  |   |  |  |  |  |  |  |  |
| EFF 94.5   |  | MIN 93.6                |             | EFF 93        |  | MIN 91.8        |         | LUB: Mobil Polyrex EM |  |   |  |  |  |  |  |  |  |
| MOTOR WEIGHT 569 LBS   |  | CONNECTION 12 Lead 2Δ/Δ |             |               |  | SER NO          |         |                       |  |   |  |  |  |  |  |  |  |
| General purpose use on industrial machinery installed in environments with minimal dirt and moisture.<br>Hernando, Mississippi |  |                         |             |               |  |                 |         |                       |  |    CC 082A |  |  |  |  |  |  |  |
|  |  |                         |             |               |  |                 |         |                       |  | <b>460V</b><br>  |  |  |  |  |  |  |  |

### APPLICATIONS:

General purpose use on pumps, fans, blowers, compressors, conveyors, material handling and other industrial machinery installed in environments with minimal dirt and moisture.