

PE254T-15-4-ODP

GENERAL PURPOSE ELECTRIC MOTOR
NEMA PREMIUM EFFICIENCY
CAST IRON CONSTRUCTION - OPEN DRIP PROOF
INVERTER DUTY 10:1 CT; 20:1 VT - NEMA MG1 PART 31

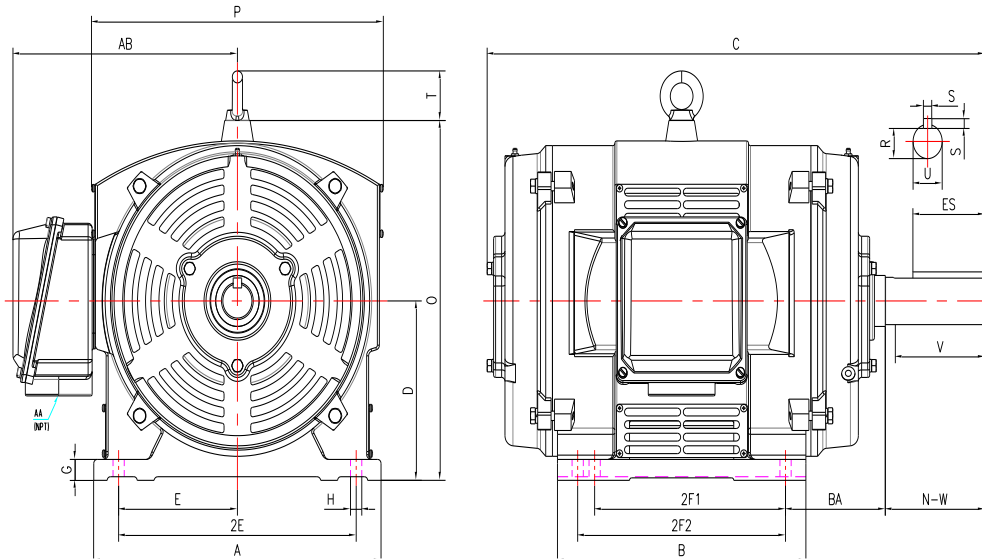

DIMENSIONS

HP	RPM	Frame	MOUNTING														
			A	B	C	D	G	H	J	E	2E	2F1	2F2	O	P	T	BA
15	1800	254T	11.85	11.65	22.15	6.25	0.70	0.53	NA	5.00	10.00	8.25	10.00	13.00	12.90	2.20	4.25

Shaft Extension, Key Set						Conduit Box		Bearings		Mount
U	V	R	S	ES	N-W	AA	AB	DE	ODE	
1.63	3.75	1.42	0.38	2.91	4.00	1.25	9.40	6309	6309	F1

BEARING LUBRICATION: The bearings come lubricated with Mobil Polyrex EM Polyurea Grease. It is recommended that you add some additional lubrication when the motor is installed.

Three options (brands) for suitable lubrication include, but are not limited to, the following:

- 1.) Mobil Polyrex EM
- 2.) Citco Polyurea MP
- 3.) Conoco Phillips Polytac EP





PE254T-15-4-ODP

GENERAL PURPOSE ELECTRIC MOTOR

NEMA PREMIUM EFFICIENCY

CAST IRON CONSTRUCTION - OPEN DRIP PROOF







INVERTER DUTY 10:1 CT; 20:1 VT - NEMA MG1 PART 31

PERFORMANCE DATA

HP	RPM	Frame	Voltage	Frequency (Hz)	Full Load S.F.	Insulation Class	NEMA Design	Slip (%)	NEMA Code	Enclosure Type	IP Rating	Max. Ambient
15	1765	254T	208-230/460	60	1.15	F	B	1.94	G	ODP	23	40° C

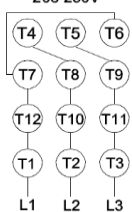
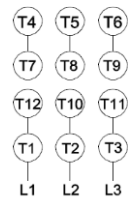
Amps (460V)		Efficiency (%)				Power Factor			Torque (ft-lb)			DE Bearing	ODE Bearing	Connection	Weight (lbs.)
FLA	LRA	100%	75%	50%	Min.	100%	75%	50%	FLT	LRT %	BDT %	6309	6309	12 Lead 2Δ/Δ	275
18.0	116.0	93.0	92.5	92.0	91.7	0.84	0.79	0.70	44.9	170	260				

NAME PLATE

 North American Electric, Inc.															CONNECTION DIAGRAMS 208-230V 		
INVERTER DUTY 20:1 VT; 10:1 CT																	
CAT NO: PE254T-15-4-ODP			FRAME 254T				PHASE 3										
HZ 60		S.F. 1.15		HZ 50		S.F. 1.0		ENCL ODP		IP 23							
HP 15		RPM 1765		HP 15		RPM 1460		DUTY CONT		DES B							
VOLTS 208-230/460			VOLTS 190/380			AMB 40° C			INS F								
FLA 40 - 36 / 18			FLA 45/23			DE BEARING 6309											
CODE G		P.F. 0.84		CODE E		P.F. 0.83		ODE BEARING 6309									
EFF 93.0		MIN 91.7		EFF 91.5		MIN 90.2		LUB: Mobil Polyrex EM									
MOTOR WEIGHT 275 LBS		CONNECTION 12 Lead 2Δ/Δ			SER NO						460V 						
General purpose use on industrial machinery installed in environments with minimal dirt and moisture. Hernando, Mississippi																CC 082A	

APPLICATIONS:

General purpose use on pumps, fans, blowers, compressors, conveyors, material handling and other industrial machinery installed in environments with minimal dirt and moisture.