

PR145T2M4A-ODP

GENERAL PURPOSE ELECTRIC MOTOR
NEMA PREMIUM EFFICIENCY
OPEN DRIP PROOF ENCLOSURE
ROLLED STEEL CONSTRUCTION
INVERTER RATED (10:1 VT; 5:1 CT)

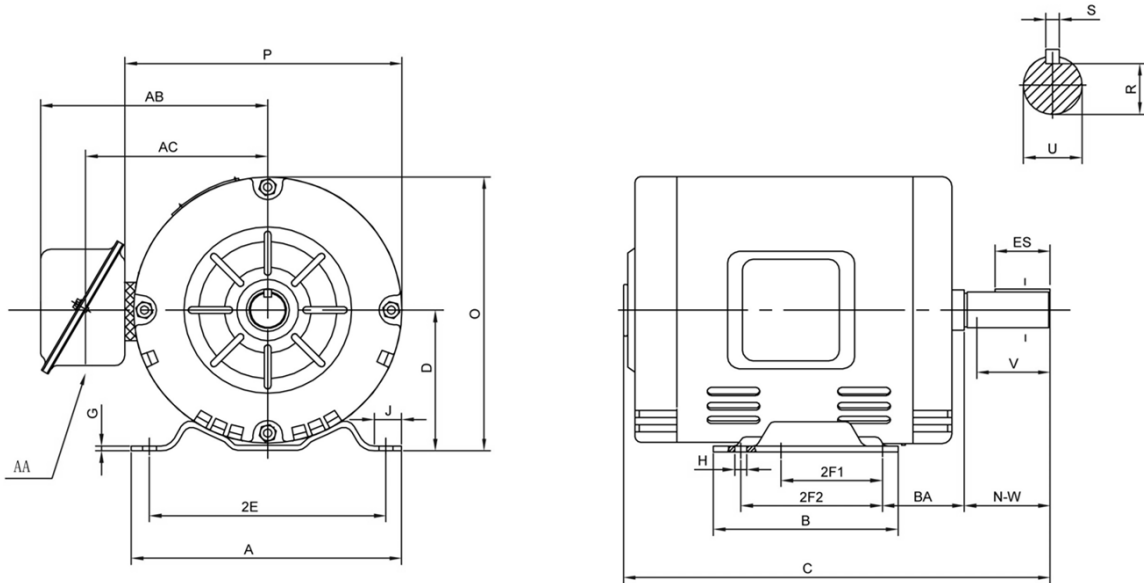

DIMENSIONS

HP	RPM	Frame	MOUNTING														
			A	B	C	D	G	H	J	E	2E	2F1	2F2	O	P	T	BA
2	1800	145T	6.50	5.90	11.80	3.50	0.12	0.35	1.18	2.75	5.50	4.00	5.00	6.70	6.60	NA	2.25

Shaft Extension, Key Set						Conduit Box		Bearings		Mount
U	V	R	S	ES	N-W	AA	AB	DE	ODE	
0.88	2.00	0.77	0.19	1.38	2.25	1.10	6.30	6205	6203	

BEARING LUBRICATION: The bearings come lubricated with Mobil Polyrex EM Polyurea Grease.





PR145T2M4A-ODP

GENERAL PURPOSE ELECTRIC MOTOR
NEMA PREMIUM EFFICIENCY
OPEN DRIP PROOF ENCLOSURE
ROLLED STEEL CONSTRUCTION
INVERTER RATED (10:1 VT; 5:1 CT)

PERFORMANCE DATA

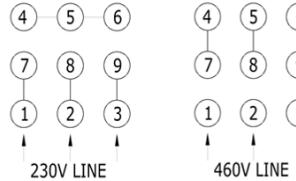
HP	RPM	Frame	Voltage	Frequency (Hz)	Full Load S.F.	Insulation Class	NEMA Design	Slip (%)	NEMA Code	Enclosure Type	IP Rating	Max. Ambient
2	1740	145T	208-230/460	60	1.15	F	B	0.033	L	ODP	IP23	40°C

Amps (460V)		Efficiency (%)			Power Factor			Torque (ft-lb)			DE Bearing	ODE Bearing	Connection	Weight (lbs.)
FLA	LRA	100%	75%	50%	100%	75%	50%	FLT	LRT %	BDT %				
3.1	23.4	84.8	83.8	80.6	0.69	0.60	0.47	8.19	336	415	6205-2RZC3	6203-2RZC3	9 Lead Y	34

NAME PLATE							
 <p>North American Electric, Inc.</p> <p>THREE PHASE ELECTRIC MOTOR</p>			<p>GENERAL PURPOSE</p> <p>NEMA Premium</p> <p>OPEN DRIP PROOF</p>				
MODEL	HP	2	RPM	1740	FRAME	145T	
PR145T2M4A-ODP	ENCL	ODP	HZ	60	PHASE	3	
VOLT	208-230/460	AMPS	6.3-5.9/2.95	S.F.	1.15	DESIGN	B
S.F. AMPS	7.24-6.8/3.4	CLASS	F	CODE	L	LBS	34
DE BEARING	6205-2RZC3						
ODE BEARING	6203-2RZC3						
RATING	CONT	MAX AMB.					40°C
SER							
Hernando, MS www.naemotors.com							

APPLICATIONS:

General purpose use on pumps, fans, blowers, compressors, conveyors, material handling and other industrial machinery where contaminants are minimal.