

**PR184T5M2A**

GENERAL PURPOSE ELECTRIC MOTOR  
 NEMA PREMIUM EFFICIENCY  
 TOTALLY ENCLOSED FAN COOLED  
 ROLLED STEEL CONSTRUCTION  
 INVERTER RATED (10:1 VT; 5:1 CT)

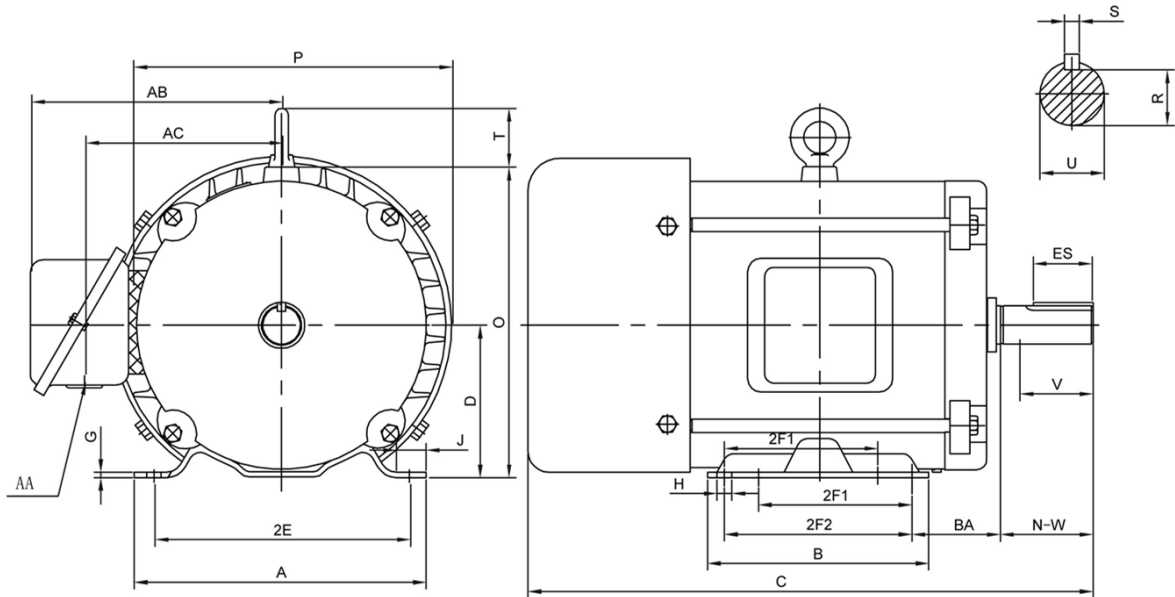

**DIMENSIONS**

HP	RPM	Frame	MOUNTING														
			A	B	C	D	G	H	J	E	2E	2F1	2F2	O	P	T	BA
5	3600	184T	8.50	6.50	15.80	4.50	0.16	0.43	0.95	3.75	7.50	4.50	5.50	9.25	10.10	2.00	2.75

Shaft Extension, Key Set						Conduit Box		Bearings		Mount
U	V	R	S	ES	N-W	AA	AB	DE	ODE	
1.13	2.50	0.99	0.25	1.75	2.75	1.10	7.30	6206	6206	

**BEARING LUBRICATION:** The bearings come lubricated with Mobil Polyrex EM Polyurea Grease.



## PR184T5M2A





**GENERAL PURPOSE ELECTRIC MOTOR**  
**NEMA PREMIUM EFFICIENCY**  
**TOTALLY ENCLOSED FAN COOLED**  
**ROLLED STEEL CONSTRUCTION**  
**INVERTER RATED (10:1 VT; 5:1 CT)**

### PERFORMANCE DATA

HP	RPM	Frame	Voltage	Frequency (Hz)	Full Load S.F.	Insulation Class	NEMA Design	Slip (%)	NEMA Code	Enclosure Type	IP Rating	Max. Ambient
5	3515	184T	208-230/460	60	1.15	F	B	0.024	H	TEFC	IP44	40°C

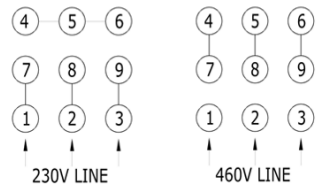
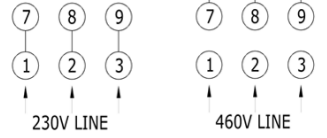
Amps (460V)		Efficiency (%)			Power Factor			Torque (ft-lb)			DE Bearing	ODE Bearing	Connection	Weight (lbs.)
FLA	LRA	100%	75%	50%	100%	75%	50%	FLT	LRT %	BDT %				
6.4	42	89.2	89.5	88.3	0.86	0.82	0.74	10.14	200	310	6206-2RZC3	6206-2RZC3	9 Lead Y	83

<b>NAME PLATE</b>											
 <b>North American Electric, Inc.</b>						<b>GENERAL PURPOSE</b>  <div style="display: flex; justify-content: center; align-items: center;"> <div style="text-align: center; margin-right: 10px;"> <b>NEMA</b>  <b>Premium</b> </div> <div style="text-align: center;"> <b>TOTALLY ENCLOSED FAN COOLED</b> </div> </div>					
<b>THREE PHASE ELECTRIC MOTOR</b>											
MODEL	HP	5	RPM	3515	FRAME	184T					
PR184T5M2A	ENCL	TEFC	HZ	60	PHASE	3					
VOLT	208-230/460	AMPS	13.0-11.8/5.9	S.F.	1.15	DESIGN	B				
S.F. AMPS	14.9-13.6/6.8	CLASS	F	CODE	H	LBS	83				
DE BEARING	6206-2RZC3										
ODE BEARING	6206-2RZC3										
RATING	CONT	MAX AMB.	40°C								
SER											
Hernando, MS <a href="http://www.naemotors.com">www.naemotors.com</a>											

#### APPLICATIONS:

General purpose use on pumps, fans, blowers, compressors, conveyors, material handling and other industrial machinery installed in damp, dusty or dirty environments.