

**PR145T2M2A**

**GENERAL PURPOSE ELECTRIC MOTOR**  
**NEMA PREMIUM EFFICIENCY**  
**TOTALLY ENCLOSED FAN COOLED**  
**ROLLED STEEL CONSTRUCTION**  
**INVERTER RATED (10:1 VT; 5:1 CT)**

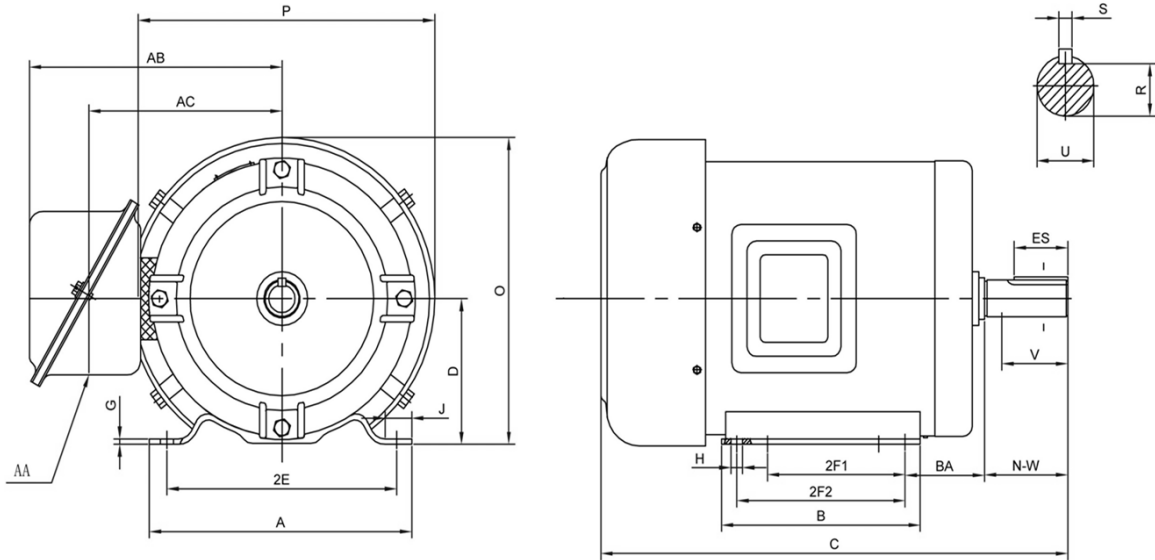

**DIMENSIONS**

HP	RPM	Frame	MOUNTING														
			A	B	C	D	G	H	J	E	2E	2F1	2F2	O	P	T	BA
2	3600	145T	6.50	5.90	13.00	3.50	0.12	0.35	1.18	2.75	5.50	4.00	5.00	7.00	6.97	NA	2.25

Shaft Extension, Key Set						Conduit Box		Bearings		Mount
U	V	R	S	ES	N-W	AA	AB	DE	ODE	
0.88	2.00	0.77	0.19	1.38	2.25	1.10	6.30	6205	6203	

**BEARING LUBRICATION:** The bearings come lubricated with Mobil Polyrex EM Polyurea Grease.

**PR145T2M2A**







**GENERAL PURPOSE ELECTRIC MOTOR**  
**NEMA PREMIUM EFFICIENCY**  
**TOTALLY ENCLOSED FAN COOLED**  
**ROLLED STEEL CONSTRUCTION**  
**INVERTER RATED (10:1 VT; 5:1 CT)**

**PERFORMANCE DATA**

HP	RPM	Frame	Voltage	Frequency (Hz)	Full Load S.F.	Insulation Class	NEMA Design	Slip (%)	NEMA Code	Enclosure Type	IP Rating	Max. Ambient
2	3500	145T	208-230/460	60	1.15	F	B	0.028	K	TEFC	IP44	40°C

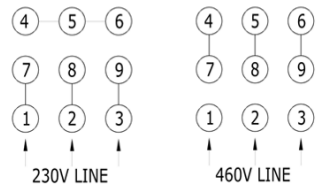
Amps (460V)		Efficiency (%)			Power Factor			Torque (ft-lb)			DE Bearing	ODE Bearing	Connection	Weight (lbs.)
FLA	LRA	100%	75%	50%	100%	75%	50%	FLT	LRT %	BDT %				
2.65	21	85.6	86.2	85.1	0.83	0.78	0.66	4.06	268	352	6205-2RZC3	6203-2RZC3	9 Lead Y	34

NAME PLATE											
 <b>North American Electric, Inc.</b>						<b>GENERAL PURPOSE</b>  <b>NEMA Premium</b> TOTALLY ENCLOSED FAN COOLED					
<b>THREE PHASE ELECTRIC MOTOR</b>											
MODEL	HP	2	RPM	3500	FRAME	145T					
PR145T2M2A	ENCL	TEFC	HZ	60	PHASE	3					
VOLT	208-230/460	AMPS	5.4-5.0/2.5	S.F.	1.15	DESIGN	B				
S.F. AMPS	6.2-5.8/2.9	CLASS	F	CODE	K	LBS	34				
DE BEARING	6203-2RZC3										
ODE BEARING	6203-2RZC3										
RATING	CONT	MAX AMB.	40°C								
SER											
Hernando, MS <a href="http://www.naemotors.com">www.naemotors.com</a>											

**APPLICATIONS:**

General purpose use on pumps, fans, blowers, compressors, conveyors, material handling and other industrial machinery installed in damp, dusty or dirty environments.