

PR56C1.5M2D

GENERAL PURPOSE ELECTRIC MOTOR
 NEMA PREMIUM EFFICIENCY
 TOTALLY ENCLOSED FAN COOLED
 ROLLED STEEL CONSTRUCTION
 INVERTER RATED (10:1 VT; 5:1 CT)

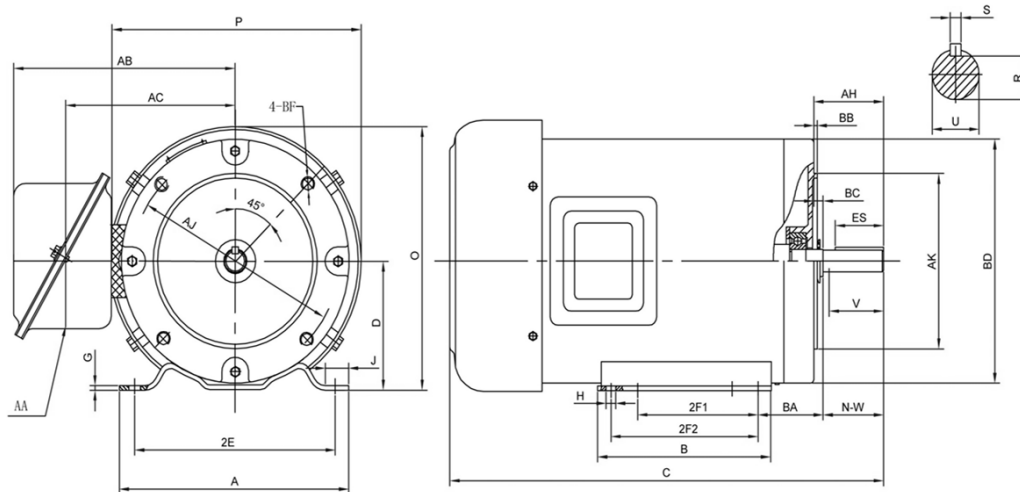

DIMENSIONS

HP	RPM	Frame	MOUNTING															
			A	B	C	D	G	H	J	E	2E	2F1	2F2	O	P	T	BA	
1.5	3600	56C	6.30	3.94	11.80	3.50	0.12	0.35	1.46	2.44	4.88	3.00	NA	7.00	6.97	NA	2.75	

FLANGE							Shaft Extension, Key Set						
AH	AJ	AK	BB	BC	BD	BF	U	V	R	S	ES	N-W	
2.07	5.875	4.50	0.16	-0.19	6.50	3/8-16UNC	0.625	1.50	0.517	0.188	1.38	1.88	

Conduit Box		Bearings		Mount
AA	AB	DE	ODE	
0.80	6.30	6203	6203	F1

BEARING LUBRICATION: The bearings come lubricated with Mobil Polyrex EM Polyurea Grease.







PR56C1.5M2D

GENERAL PURPOSE ELECTRIC MOTOR
NEMA PREMIUM EFFICIENCY
TOTALLY ENCLOSED FAN COOLED
ROLLED STEEL CONSTRUCTION
INVERTER RATED (10:1 VT; 5:1 CT)

PERFORMANCE DATA

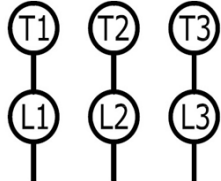
HP	RPM	Frame	Voltage	Frequency (Hz)	Full Load S.F.	Insulation Class	NEMA Design	Slip (%)	NEMA Code	Enclosure Type	IP Rating	Max. Ambient
1.5	3510	56C	208-230/460	60	1.15	F	B	0.025	L	TEFC	IP44	40°C

Amps (460V)		Efficiency (%)			Power Factor			Torque (ft-lb)			DE Bearing	ODE Bearing	Connection	Weight (lbs.)
FLA	LRA	100%	75%	50%	100%	75%	50%	FLT	LRT %	BDT %				
1.68	14.7	84.4	83.4	80.6	0.79	0.78	0.66	1.96	338	390	6203-2RZC3	6203-2RZC3	9 Lead 2Y/Y	28

NAME PLATE											
 North American Electric, Inc. THREE PHASE ELECTRIC MOTOR						GENERAL PURPOSE NEMA Premium TOTALLY ENCLOSED FAN COOLED					
MODEL	HP	1.5	RPM	3510	FRAME	56C					
PR56C1.5M2D	ENCL	TEFC	HZ	60	PHASE	3					
VOLT	208-230/460	AMPS	1.6	S.F.	1.15	DESIGN	B				
S.F. AMPS	1.8	CLASS	F	CODE	L	LBS	28				
DE BEARING	6203-2RZC3										
ODE BEARING	6203-2RZC3										
RATING	CONT	MAX AMB.	40°C								
SER											
Hernando, MS www.naemotors.com											

APPLICATIONS:

General purpose use on pumps, fans, blowers, compressors, conveyors, material handling and other industrial machinery installed in damp, dusty or dirty environments.