

PE445T-125-6C

GENERAL PURPOSE ELECTRIC MOTOR

NEMA PREMIUM EFFICIENCY

TOTALLY ENCLOSED FAN COOLED

INVERTER DUTY 10:1 CT; 20:1 VT - NEMA MG1 PART 31

Factory Certified for T2B Class I, Division II, Groups A,B,C & D and Class II, Division II, Groups F & G

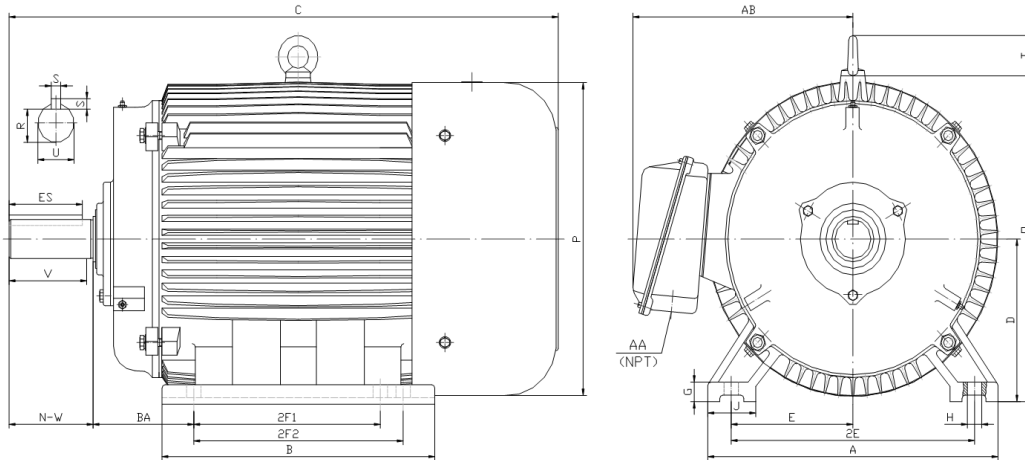

DIMENSIONS

HP	RPM	Frame	MOUNTING														
			A	B	C	D	G	H	J	E	2E	2F1	2F2	O	P	T	BA
125	1200	445T	21.70	22.90	44.30	11.00	1.35	0.81	3.35	9.00	18.00	14.50	16.50	23.00	23.40	3.00	7.50

Shaft Extension, Key Set						Conduit Box		Bearings		Mount
U	V	R	S	ES	N-W	AA	AB	DE	ODE	
3.375	8.25	2.880	0.875	6.91	8.50	3.00	19.90	NU319	6318	F1

BEARING LUBRICATION: The bearings come lubricated with Mobil Polyrex EM Polyurea Grease. It is recommended that you add some additional lubrication when the motor is installed.

Three options (brands) for suitable lubrication include, but are not limited to, the following:

- 1.) Mobil Polyrex EM
- 2.) Citco Polyurea MP
- 3.) Conoco Phillips Polytac EP





PE445T-125-6C

GENERAL PURPOSE ELECTRIC MOTOR

NEMA PREMIUM EFFICIENCY

TOTALLY ENCLOSED FAN COOLED

INVERTER DUTY 10:1 CT; 20:1 VT - NEMA MG1 PART 31







Factory Certified for T2B Class I, Division II, Groups A,B,C & D and Class II, Division II, Groups F & G

PERFORMANCE DATA

HP	RPM	Frame	Voltage	Frequency (Hz)	Full Load S.F.	Insulation Class	NEMA Design	Slip (%)	NEMA Code	Enclosure Type	IP Rating	Max. Ambient
125	1185	445T	460	60	1.15	F	C	1.3	G	TEFC	55	40° C

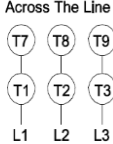
Amps (460V)		Efficiency (%)				Power Factor			Torque (ft-lb)			DE Bearing	ODE Bearing	Connection	Weight (lbs.)
FLA	LRA	100%	75%	50%	Min.	100%	75%	50%	FLT	LRT %	BDT %				
150.0	907	95.0	95.0	95.0	94.1	0.790	0.770	0.700	553.5	200	250	NU319	6318	6 Lead Δ	1644

NAME PLATE

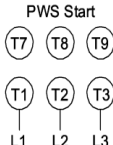
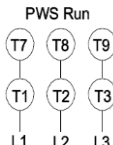
 North American Electric, Inc.													CONNECTION DIAGRAMS (460V)										
INVERTER DUTY 20:1 VT; 10:1 CT																							
CAT NO:		PE445T-125-6C			FRAME		445T		PHASE		3												
HZ		60		S.F.		1.15		HZ		50		S.F.		1.0		ENCL		TEFC		IP		55	
HP		125		RPM		1185		HP		125		RPM		985		DUTY		CONT		DES		C	
VOLTS				460				VOLTS				380				AMB		40° C		INS		F	
FLA				150.0				FLA				185				DE BEARING				NU319			
CODE		G		P.F.		0.79		CODE		F		P.F.		0.82		ODE BEARING				6318			
EFF		95.0		MIN		94.1		EFF		93.5		MIN		92.6		LUB: Mobil Polyrex EM							
MOTOR WEIGHT				1644.0				LBS		CONNECTION				6 Lead Δ				SER NO					
General purpose use on industrial machinery installed in damp, dusty or dirty environments. Hernando, Mississippi																CC 082A							
																							

APPLICATIONS:

General purpose use on pumps, fans, blowers, compressors, conveyors, material handling and other industrial machinery installed in damp, dusty or dirty environments.