

PE587U-350-4C

CRUSHER DUTY MOTOR

HIGH TORQUE / PREMIUM EFFICIENCY DESIGN

TOTALLY ENCLOSED FAN COOLED

HEAVY DUTY CAST IRON CONSTRUCTION

Factory Certified for T2B Class I, Division II, Groups A,B,C & D and Class II, Division II, Groups F & G

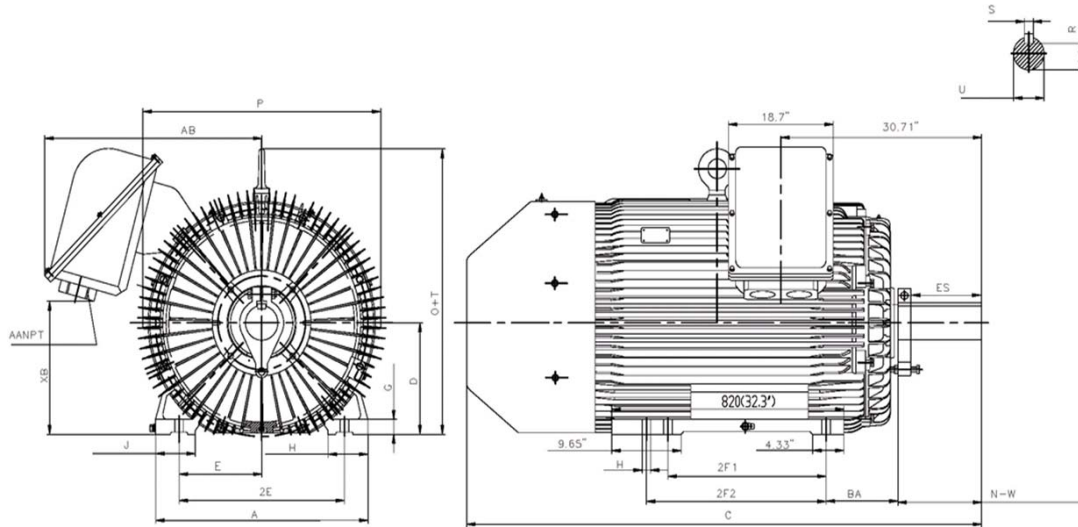

DIMENSIONS

HP	RPM	Frame	MOUNTING														
			A	B	C	D	G	H	J	E	2E	2F1	2F2	O	P	T	BA
350	1800	587U	29.53	32.38	71.65	14.50	1.97	1.13	5.51	11.50	23.00	22.00	25.00	41.36	33.07	5.88	10.00

Shaft Extension, Key Set						Conduit Box		Bearings		Mount
U	V	R	S	ES	N-W	AA	AB	DE	ODE	
3.875	11.25	3.817	1.00	10.00	11.63	2 X 3"	28.15	NU324	6319	F1

BEARING LUBRICATION: The bearings come lubricated with Mobil Polyrex EM Polyurea Grease. It is recommended that you add some additional lubrication when the motor is installed.

Three options (brands) for suitable lubrication include, but are not limited to, the following:

- 1.) Mobil Polyrex EM
- 2.) Citco Polyurea MP
- 3.) Conoco Phillips Polytac EP





PE587U-350-4C

CRUSHER DUTY MOTOR
HIGH TORQUE / PREMIUM EFFICIENCY DESIGN
TOTALLY ENCLOSED FAN COOLED
HEAVY DUTY CAST IRON CONSTRUCTION





Factory Certified for T2B Class I, Division II, Groups A,B,C & D and Class II, Division II, Groups F & G

PERFORMANCE DATA

HP	RPM	Frame	Voltage	Frequency (Hz)	Full Load S.F.	Insulation Class	NEMA Design	Slip (%)	NEMA Code	Enclosure Type	IP Rating	Max. Ambient
350	1788	587U	460	60	1.15	F	C	0.7	G	TEFC	55	40° C

Amps (460V)		Efficiency (%)				Power Factor			Torque (ft-lb)			DE Bearing	ODE Bearing	Connection	Weight (lbs.)
FLA	LRA	100%	75%	50%	Min.	100%	75%	50%	FLT	LRT %	BDT %	NU324	6319	12 Lead Δ	4847
378.5	2550	96.2	95.8	95.2	95.4	0.882	0.863	0.824	1389	200	270				

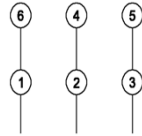
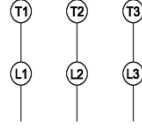
NAME PLATE

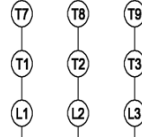
 										CONNECTION DIAGRAMS Across The Line 					
CAT NO: PE587U-350-4C			FRAME 587U			PHASE 3									
DE BRG NU324		ODE BRG 6319		CONN. 12 Lead Δ											
MAX AMB. 40° C		INS. CLASS F		RATING CONT		WEIGHT 4847									
LUBRICATION Mobil Polyrex EM				SER											
60 HERTZ DATA	HP 350		RPM 1788		HP 350		RPM 1490								
	VOLTS 460				VOLTS 380										
	F.L. AMPS 378.5				F.L. AMPS 458.2										
	S.F. AMPS 435.3				S.F. AMPS 458.2										
	S.F. 1.15		DESIGN C		CODE G		S.F. 1.0		DESIGN C		CODE H				
	NEMA NOM.EFF. 96.2 %		NOM. P.F. 0.882		NEMA NOM.EFF. 95.1 %		NOM. P.F. 0.882								
	NEMA MIN.EFF. 95.4 %		MAX. KVAR 43.0		NEMA MIN.EFF. 94.4 %		MAX. KVAR 45.1								
Designed specifically for use on crushing and pulverizing equipment and other equipment requiring extremely high starting torques and breakdown torques.										PWS Start 					
ISO9001 CERTIFIED   CC041B Hernando, MS 38632										PWS Run 					

APPLICATIONS:

Special purpose use on crushing and pulverizing equipment and other industrial equipment requiring extremely high starting torques and breakdown torques.