

PE405T-100-4C

GENERAL PURPOSE ELECTRIC MOTOR

NEMA PREMIUM EFFICIENCY

TOTALLY ENCLOSED FAN COOLED

INVERTER DUTY 10:1 CT; 20:1 VT - NEMA MG1 PART 31

Factory Certified for T2B Class I, Division II, Groups A,B,C & D and Class II, Division II, Groups F & G

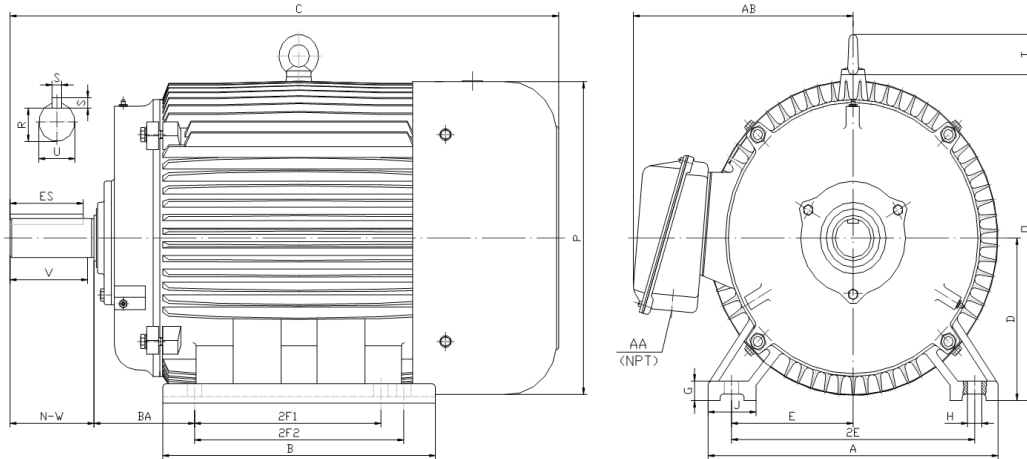

DIMENSIONS

| HP | RPM | Frame | MOUNTING | | | | | | | | | | | | | | |
|-----|------|-------|----------|-------|-------|-------|------|------|------|------|-------|-------|-------|-------|-------|------|------|
| | | | A | B | C | D | G | H | J | E | 2E | 2F1 | 2F2 | O | P | T | BA |
| 100 | 1800 | 405T | 19.30 | 17.90 | 40.00 | 10.00 | 1.25 | 0.81 | 3.15 | 8.00 | 16.00 | 12.25 | 13.75 | 21.10 | 21.60 | 2.60 | 6.62 |

| Shaft Extension, Key Set | | | | | | Conduit Box | | Bearings | | Mount |
|--------------------------|------|-------|-------|------|------|-------------|-------|----------|------|-------|
| U | V | R | S | ES | N-W | AA | AB | DE | ODE | |
| 2.875 | 7.00 | 2.450 | 0.750 | 5.65 | 7.25 | 3.00 | 16.60 | NU318 | 6314 | F1 |

BEARING LUBRICATION: The bearings come lubricated with Mobil Polyrex EM Polyurea Grease. It is recommended that you add some additional lubrication when the motor is installed.

Three options (brands) for suitable lubrication include, but are not limited to, the following:

- 1.) Mobil Polyrex EM
- 2.) Citco Polyurea MP
- 3.) Conoco Phillips Polytac EP





PE405T-100-4C

GENERAL PURPOSE ELECTRIC MOTOR

NEMA PREMIUM EFFICIENCY

TOTALLY ENCLOSED FAN COOLED

INVERTER DUTY 10:1 CT; 20:1 VT - NEMA MG1 PART 31







Factory Certified for T2B Class I, Division II, Groups A,B,C & D and Class II, Division II, Groups F & G

PERFORMANCE DATA

| HP | RPM | Frame | Voltage | Frequency (Hz) | Full Load S.F. | Insulation Class | NEMA Design | Slip (%) | NEMA Code | Enclosure Type | IP Rating | Max. Ambient |
|-----|------|-------|-------------|----------------|----------------|------------------|-------------|----------|-----------|----------------|-----------|--------------|
| 100 | 1785 | 405T | 208-230/460 | 60 | 1.15 | F | C | 0.8 | G | TEFC | 55 | 40° C |

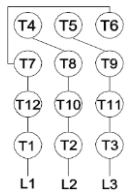
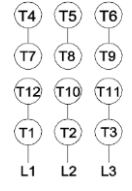
| Amps (460V) | | Efficiency (%) | | | | Power Factor | | | Torque (ft-lb) | | | DE Bearing | ODE Bearing | Connection | Weight (lbs.) |
|-------------|-----|----------------|------|------|------|--------------|-------|-------|----------------|-------|-------|------------|-------------|--------------|---------------|
| FLA | LRA | 100% | 75% | 50% | Min. | 100% | 75% | 50% | FLT | LRT % | BDT % | | | | |
| 112.0 | 725 | 95.4 | 95.4 | 95.2 | 94.5 | 0.870 | 0.840 | 0.770 | 295.2 | 200 | 260 | NU318 | 6314 | 12 Lead 2Δ/Δ | 1228 |

NAME PLATE

| | | | | | | | | | | | | | | | | | | | | | | | | | | |
|---|--|-----------------|--|------|--|------------|--|--------------|--|---|--|---|--|--|--|--|---|--|-----------------------|--|------|--|------|--|----|--|
|  North American Electric, Inc. | | | | | | | | | |  | | | CONNECTION DIAGRAMS 208-230V  | | | | | | | | | | | | | |
| INVERTER DUTY 20:1 VT; 10:1 CT | | | | | | | | | | | | | | | | | | | | | | | | | | |
| CAT NO: | | PE405T-100-4C | | | | FRAME | | 405T | | PHASE | | 3 | | 460V  | | | | | | | | | | | | |
| HZ | | 60 | | S.F. | | 1.15 | | HZ | | 50 | | S.F. | | | | | 1.0 | | ENCL | | TEFC | | IP | | 55 | |
| HP | | 100 | | RPM | | 1785 | | HP | | 100 | | RPM | | | | | 1485 | | DUTY | | CONT | | DES | | C | |
| VOLTS | | 208-230/460 | | | | VOLTS | | 190/380 | | AMB | | 40° C | | | | | INS | | F | | | | | | | |
| FLA | | 248 - 224 / 112 | | | | FLA | | 274/137 | | DE BEARING | | | | | | | NU318 | | | | | | | | | |
| CODE | | G | | P.F. | | 0.87 | | CODE | | F | | P.F. | | | | | 0.88 | | ODE BEARING | | | | 6314 | | | |
| EFF | | 95.4 | | MIN | | 94.5 | | EFF | | 94.1 | | MIN | | | | | 93.2 | | LUB: Mobil Polyrex EM | | | | | | | |
| MOTOR WEIGHT | | 1228 | | LBS | | CONNECTION | | 12 Lead 2Δ/Δ | | SER NO | | | | | | | | | | | | | | | | |
| General purpose use on industrial machinery installed in damp, dusty or dirty environments. Hernando, Mississippi | | | | | | | | | |  | |  | | | | |  | | CC 082A | | | | | | | |

APPLICATIONS:

General purpose use on pumps, fans, blowers, compressors, conveyors, material handling and other industrial machinery installed in damp, dusty or dirty environments.