

PE444T-75-8C

GENERAL PURPOSE ELECTRIC MOTOR

NEMA PREMIUM EFFICIENCY

TOTALLY ENCLOSED FAN COOLED

INVERTER DUTY 10:1 CT; 20:1 VT - NEMA MG1 PART 31

Factory Certified for T2B Class I, Division II, Groups A,B,C & D and Class II, Division II, Groups F & G

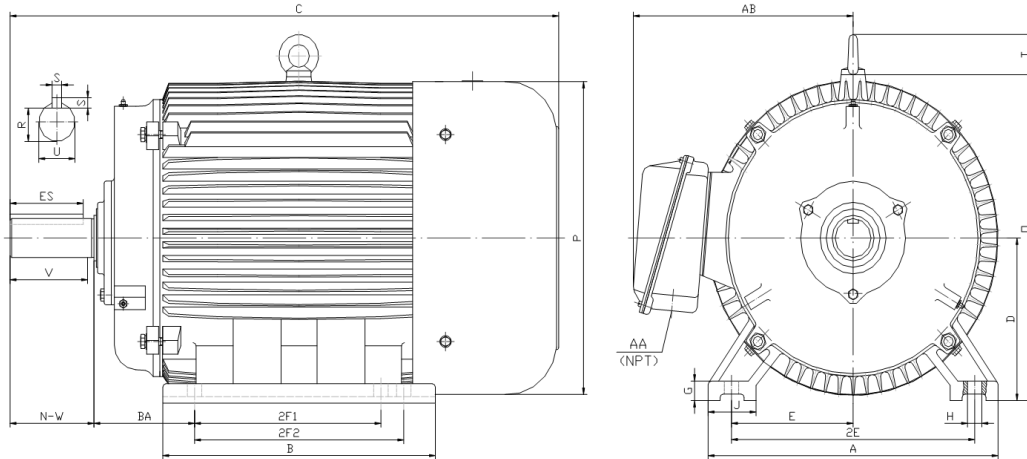

DIMENSIONS

HP	RPM	Frame	MOUNTING														
			A	B	C	D	G	H	J	E	2E	2F1	2F2	O	P	T	BA
75	900	444T	21.70	22.90	44.30	11.00	1.35	0.81	3.35	9.00	18.00	14.50	16.50	22.10	21.60	3.00	7.50

Shaft Extension, Key Set						Conduit Box		Bearings		Mount
U	V	R	S	ES	N-W	AA	AB	DE	ODE	
3.375	8.25	2.880	0.875	6.91	8.50	3.00	19.00	NU319	6318	F1

BEARING LUBRICATION: The bearings come lubricated with Mobil Polyrex EM Polyurea Grease. It is recommended that you add some additional lubrication when the motor is installed.

Three options (brands) for suitable lubrication include, but are not limited to, the following:

- 1.) Mobil Polyrex EM
- 2.) Citco Polyurea MP
- 3.) Conoco Phillips Polytac EP





PE444T-75-8C

GENERAL PURPOSE ELECTRIC MOTOR

NEMA PREMIUM EFFICIENCY

TOTALLY ENCLOSED FAN COOLED

INVERTER DUTY 10:1 CT; 20:1 VT - NEMA MG1 PART 31







Factory Certified for T2B Class I, Division II, Groups A,B,C & D and Class II, Division II, Groups F & G

PERFORMANCE DATA

HP	RPM	Frame	Voltage	Frequency (Hz)	Full Load S.F.	Insulation Class	NEMA Design	Slip (%)	NEMA Code	Enclosure Type	IP Rating	Max. Ambient
75	885	444T	208-230/460	60	1.15	F	C	1.7	G	TEFC	55	40° C

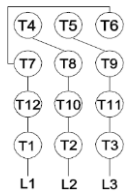
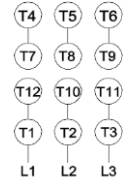
Amps (460V)		Efficiency (%)				Power Factor			Torque (ft-lb)			DE Bearing	ODE Bearing	Connection	Weight (lbs.)
FLA	LRA	100%	75%	50%	Min.	100%	75%	50%	FLT	LRT %	BDT %				
95.0	542	93.6	93.6	92.5	92.4	0.800	0.720	0.600	445.0	200	240	NU319	6318	12 Lead 2Δ/Δ	1353

NAME PLATE

 North American Electric, Inc.													CONNECTION DIAGRAMS 208-230V 										
INVERTER DUTY 20:1 VT; 10:1 CT																							
CAT NO:		PE444T-75-8C				FRAME		444T		PHASE		3		460V 									
HZ		60		S.F.		1.15		HZ		50		S.F.					1.0		ENCL		TEFC		IP
HP		75		RPM		885		HP		75		RPM		740		DUTY		CONT		DES		C	
VOLTS		208-230/460				VOLTS		190/380		AMB		40° C		INS		F							
FLA		210 - 190 / 95				FLA		230/115		DE BEARING				NU319									
CODE		G		P.F.		0.80		CODE		F		P.F.		0.82		ODE BEARING				6318			
EFF		93.6		MIN		92.4		EFF		92		MIN		90.5		LUB: Mobil Polyrex EM							
MOTOR WEIGHT		1353		LBS		CONNECTION		12 Lead 2Δ/Δ		SER NO													
General purpose use on industrial machinery installed in damp, dusty or dirty environments. Hernando, Mississippi																CC 082A							

APPLICATIONS:

General purpose use on pumps, fans, blowers, compressors, conveyors, material handling and other industrial machinery installed in damp, dusty or dirty environments.