

PE215T-5-6-575V

GENERAL PURPOSE ELECTRIC MOTOR

NEMA PREMIUM EFFICIENCY

TOTALLY ENCLOSED FAN COOLED

INVERTER DUTY 10:1 CT; 20:1 VT - NEMA MG1 PART 31

Factory Certified for T2B Class I, Division II, Groups A,B,C & D and Class II, Division II, Groups F & G

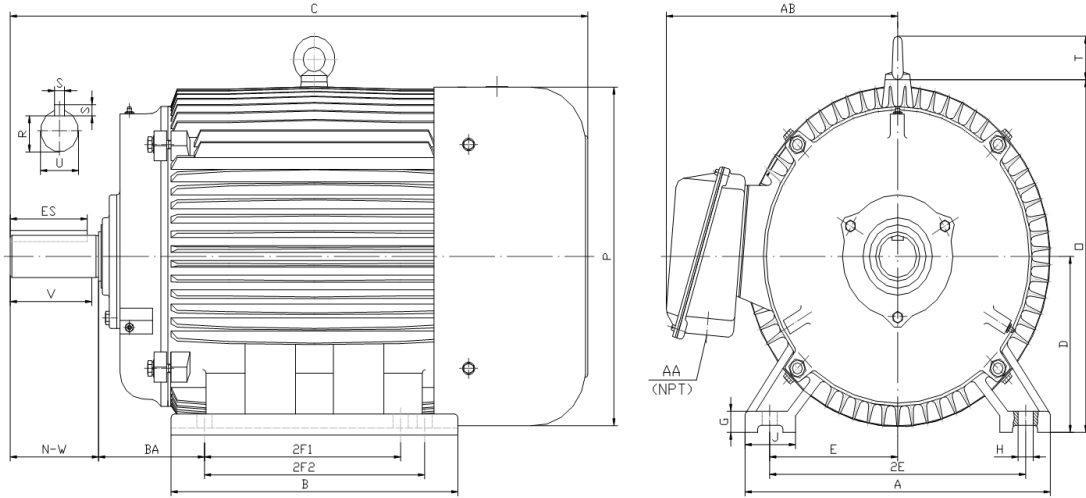

DIMENSIONS

HP	RPM	Frame	MOUNTING														
			A	B	C	D	G	H	J	E	2E	2F1	2F2	O	P	T	BA
5	1200	215T	11.00	9.40	20.40	5.25	0.70	0.41	2.40	4.25	8.50	5.50	7.00	11.20	11.60	1.90	3.50

Shaft Extension, Key Set						Conduit Box		Bearings		Mount
U	V	R	S	ES	N-W	AA	AB	DE	ODE	
1.38	3.12	1.20	0.31	2.41	3.38	1.00	9.00	6308-ZZ	6308-ZZ	F1

BEARING LUBRICATION: The bearings come lubricated with Mobil Polyrex EM Polyurea Grease.





PE215T-5-6-575V

GENERAL PURPOSE ELECTRIC MOTOR

NEMA PREMIUM EFFICIENCY

TOTALLY ENCLOSED FAN COOLED

INVERTER DUTY 10:1 CT; 20:1 VT - NEMA MG1 PART 31

Factory Certified for T2B Class I, Division II, Groups A,B,C & D and Class II, Division II, Groups F & G

PERFORMANCE DATA

HP	RPM	Frame	Voltage	Frequency (Hz)	Full Load S.F.	Insulation Class	NEMA Design	Slip (%)	NEMA Code	Enclosure Type	IP Rating	Max. Ambient
5	1180	215T	575	60	1.15	F	B	1.7	J	TEFC	55	40° C

Amps (575V)		Efficiency (%)				Power Factor			Torque (ft-lb)			DE Bearing	ODE Bearing	Connection	Weight (lbs.)
FLA	LRA	100%	75%	50%	Min.	100%	75%	50%	FLT	LRT %	BDT %				
5.7	37.0	89.5	89.0	87.5	87.5	0.730	0.660	0.540	22.5	190	280	6308-ZZ	6308-ZZ	3 Lead Y	162

NAME PLATE

				CONNECTION DIAGRAM 575 V Wye 			
INVERTER DUTY 20:1 VT; 10:1 CT							
CAT NO:	PE215T-5-6-575V	HP	5	Hz	60	PHASE	3
VOLTS	575	FLA	5.7	IP RATING	55		
RPM	1180	POWER FACTOR	0.73	DESIGN	B		
FRAME	215T	NEMA NOM EFF	89.5	CODE	J		
DRIVE END BEARING	6308-ZZ	NEMA MIN EFF	87.5	S.F.	1.15		
OPP DRIVE END BEARING	6308-ZZ	MAX AMB	40° C	INS CLASS	F		
ENCL	TEFC	RATING	CONT	SER			
MOTOR WEIGHT	162 LBS	CONNECTION	3 Lead Y	LUB:	Mobil Polyrex EM		
General purpose use on industrial machinery installed in damp, dusty or dirty environments. Hernando, Mississippi							CC 082A

APPLICATIONS:

General purpose use on pumps, fans, blowers, compressors, conveyors, material handling and other industrial machinery installed in damp, dusty or dirty environments.