

**PE256T-20-4C**

GENERAL PURPOSE ELECTRIC MOTOR

NEMA PREMIUM EFFICIENCY

TOTALLY ENCLOSED FAN COOLED

INVERTER DUTY 10:1 CT; 20:1 VT - NEMA MG1 PART 31

Factory Certified for T2B Class I, Division II, Groups A,B,C & D and Class II, Division II, Groups F & G

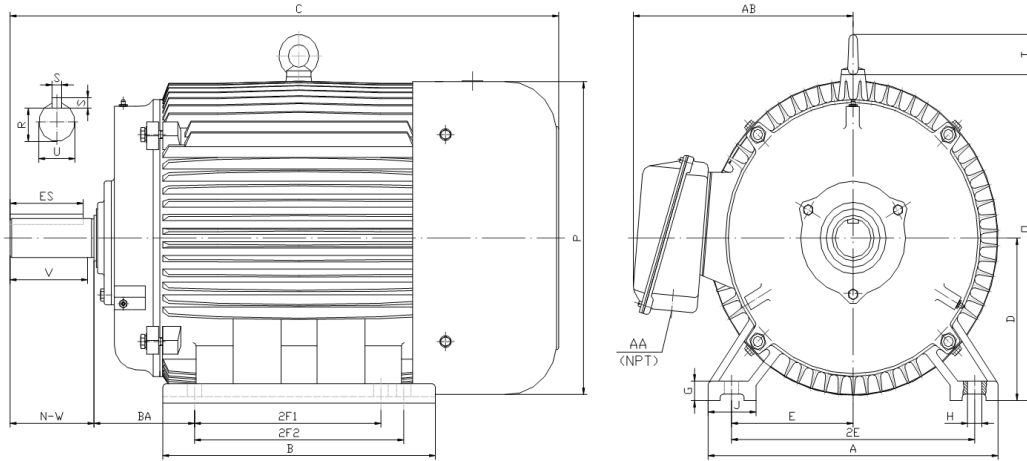

**DIMENSIONS**

HP	RPM	Frame	MOUNTING														
			A	B	C	D	G	H	J	E	2E	2F1	2F2	O	P	T	BA
20	1800	256T	13.00	12.20	25.00	6.25	0.70	0.53	2.75	5.00	10.00	8.25	10.00	13.20	12.80	2.20	4.25

Shaft Extension, Key Set						Conduit Box		Bearings		Mount
U	V	R	S	ES	N-W	AA	AB	DE	ODE	
1.625	3.75	1.416	0.375	2.91	4.00	1.25	10.30	6309	6309	F1

**BEARING LUBRICATION:** The bearings come lubricated with Mobil Polyrex EM Polyurea Grease. It is recommended that you add some additional lubrication when the motor is installed.

Three options (brands) for suitable lubrication include, but are not limited to, the following:

- 1.) Mobil Polyrex EM
- 2.) Citco Polyurea MP
- 3.) Conoco Phillips Polytac EP





## PE256T-20-4C

GENERAL PURPOSE ELECTRIC MOTOR

NEMA PREMIUM EFFICIENCY

TOTALLY ENCLOSED FAN COOLED

INVERTER DUTY 10:1 CT; 20:1 VT - NEMA MG1 PART 31







Factory Certified for T2B Class I, Division II, Groups A,B,C & D and Class II, Division II, Groups F & G

### PERFORMANCE DATA

HP	RPM	Frame	Voltage	Frequency (Hz)	Full Load S.F.	Insulation Class	NEMA Design	Slip (%)	NEMA Code	Enclosure Type	IP Rating	Max. Ambient
20	1760	256T	208-230/460	60	1.15	F	C	2.2	G	TEFC	55	40° C

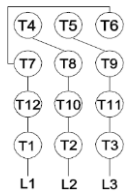
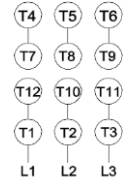
Amps (460V)		Efficiency (%)				Power Factor			Torque (ft-lb)			DE Bearing	ODE Bearing	Connection	Weight (lbs.)
FLA	LRA	100%	75%	50%	Min.	100%	75%	50%	FLT	LRT %	BDT %	6309	6309	12 Lead 2Δ/Δ	301
24.2	145	93.0	93.2	93.0	91.7	0.830	0.780	0.670	59.8	200	270				

### NAME PLATE

 <b>North American Electric, Inc.</b>													<b>CONNECTION DIAGRAMS</b> <b>208-230V</b>  <b>460V</b> 										
<b>INVERTER DUTY 20:1 VT; 10:1 CT</b>																							
CAT NO:		PE256T-20-4C				FRAME		256T		PHASE		3											
HZ		60		S.F.		1.15		HZ		50		S.F.		1.0		ENCL		TEFC		IP		55	
HP		20		RPM		1760		HP		20		RPM		1460		DUTY		CONT		DES		C	
VOLTS				208-230/460				VOLTS				190/380				AMB		40° C		INS		F	
FLA		51.8 - 48.4 / 24.2				FLA				58/29				DE BEARING				6309					
CODE		G		P.F.		0.83		CODE		F		P.F.		0.85		ODE BEARING				6309			
EFF		93.0		MIN		91.7		EFF		91.5		MIN		90.2		LUB: Mobil Polyrex EM							
MOTOR WEIGHT				301		LBS		CONNECTION				12 Lead 2Δ/Δ		SER NO									
General purpose use on industrial machinery installed in damp, dusty or dirty environments. Hernando, Mississippi																CC 082A							

### APPLICATIONS:

General purpose use on pumps, fans, blowers, compressors, conveyors, material handling and other industrial machinery installed in damp, dusty or dirty environments.