

PE143T-1-4

GENERAL PURPOSE ELECTRIC MOTOR

NEMA PREMIUM EFFICIENCY

TOTALLY ENCLOSED FAN COOLED

INVERTER DUTY 10:1 CT; 20:1 VT - NEMA MG1 PART 31

Factory Certified for T2B Class I, Division II, Groups A,B,C & D and Class II, Division II, Groups F & G

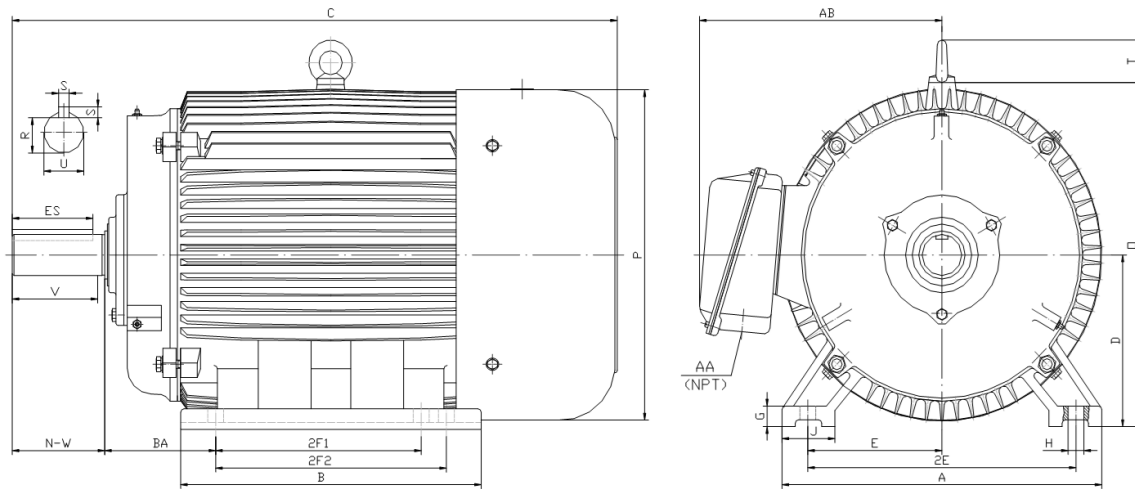

DIMENSIONS

HP	RPM	Frame	MOUNTING														
			A	B	C	D	G	H	J	E	2E	2F1	2F2	O	P	T	BA
1	1800	143T	7.00	5.20	13.60	3.50	0.50	0.34	1.40	2.75	5.50	4.00	5.00	7.10	6.95	0.00	2.25

Shaft Extension, Key Set						Conduit Box		Bearings		Mount
U	V	R	S	ES	N-W	AA	AB	DE	ODE	
0.875	2.00	0.771	0.188	1.41	2.25	0.75	6.10	6205-ZZ	6205-ZZ	F1

BEARING LUBRICATION: The bearings come lubricated with Mobil Polyrex EM Polyurea Grease.





PE143T-1-4

GENERAL PURPOSE ELECTRIC MOTOR

NEMA PREMIUM EFFICIENCY

TOTALLY ENCLOSED FAN COOLED

INVERTER DUTY 10:1 CT; 20:1 VT - NEMA MG1 PART 31







Factory Certified for T2B Class I, Division II, Groups A,B,C & D and Class II, Division II, Groups F & G

PERFORMANCE DATA

HP	RPM	Frame	Voltage	Frequency (Hz)	Full Load S.F.	Insulation Class	NEMA Design	Slip (%)	NEMA Code	Enclosure Type	IP Rating	Max. Ambient
1	1745	143T	208-230/460	60	1.15	F	B	3.1	M	TEFC	55	40° C

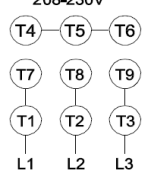
Amps (460V)		Efficiency (%)				Power Factor			Torque (ft-lb)			DE Bearing	ODE Bearing	Connection	Weight (lbs.)
FLA	LRA	100%	75%	50%	Min.	100%	75%	50%	FLT	LRT %	BDT %				
1.5	15	85.5	85.0	83.6	82.5	0.710	0.620	0.490	3.0	275	310	6205-ZZ	6205-ZZ	9 Lead 2Y/Y	47

NAME PLATE

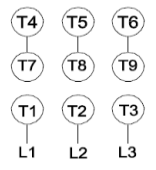
 North American Electric, Inc.															CONNECTION DIAGRAMS 208-230V 		
INVERTER DUTY 20:1 VT; 10:1 CT																	
CAT NO: PE143T-1-4			FRAME 143T			PHASE 3											
HZ 60	S.F. 1.15	HZ 50	S.F. 1.0	ENCL TEFC	IP 55												
HP 1	RPM 1745	HP 1	RPM 1430	DUTY CONT	DES B												
VOLTS 208-230/460		VOLTS 190/380		AMB 40° C	INS F												
FLA 3.2 - 3 / 1.5		FLA 3.6/1.8		DE BEARING 6205-ZZ													
CODE M	P.F. 0.71	CODE H	P.F. 0.77	ODE BEARING 6205-ZZ													
EFF 85.5	MIN 82.5	EFF 83	MIN 80	LUB: Mobil Polyrex EM													
MOTOR WEIGHT 47 LBS		CONNECTION 9 Lead 2Y/Y		SER NO													
General purpose use on industrial machinery installed in damp, dusty or dirty environments. Hernando, Mississippi										   CC 082A							
										460V 							

APPLICATIONS:

General purpose use on pumps, fans, blowers, compressors, conveyors, material handling and other industrial machinery installed in damp, dusty or dirty environments.