

Dimensões em polegada
Dimensions in inches

THIS IS AN UPDATED REVISION, THE
PREVIOUS ONE MUST BE DISREGARDED.

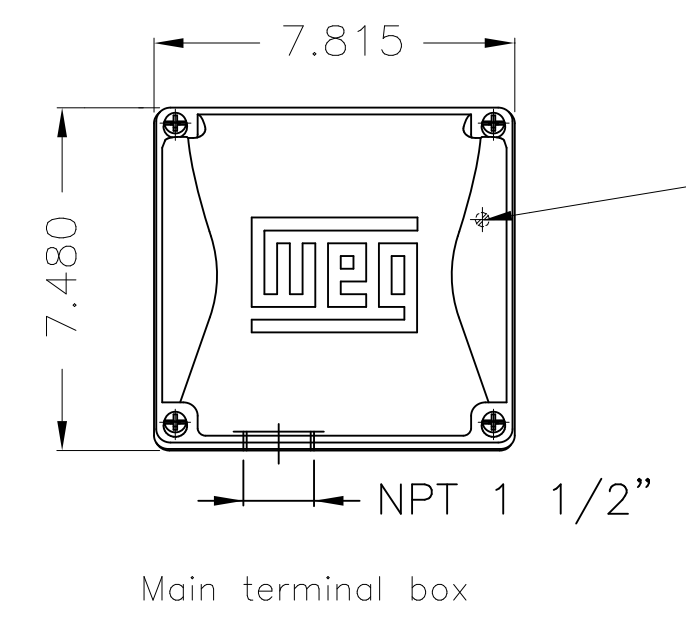

Grounding for leads 5.2-25 mm² / 10-4 AWG

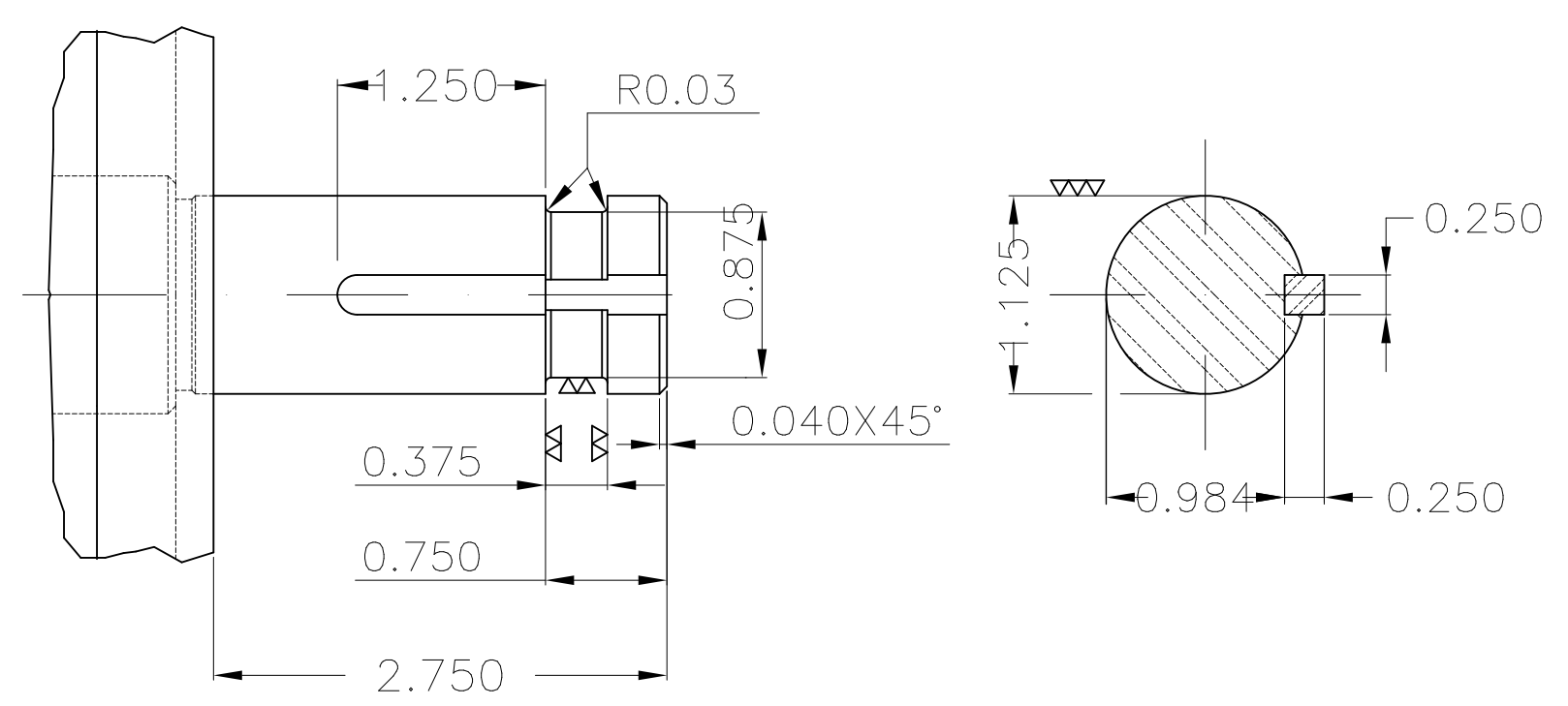
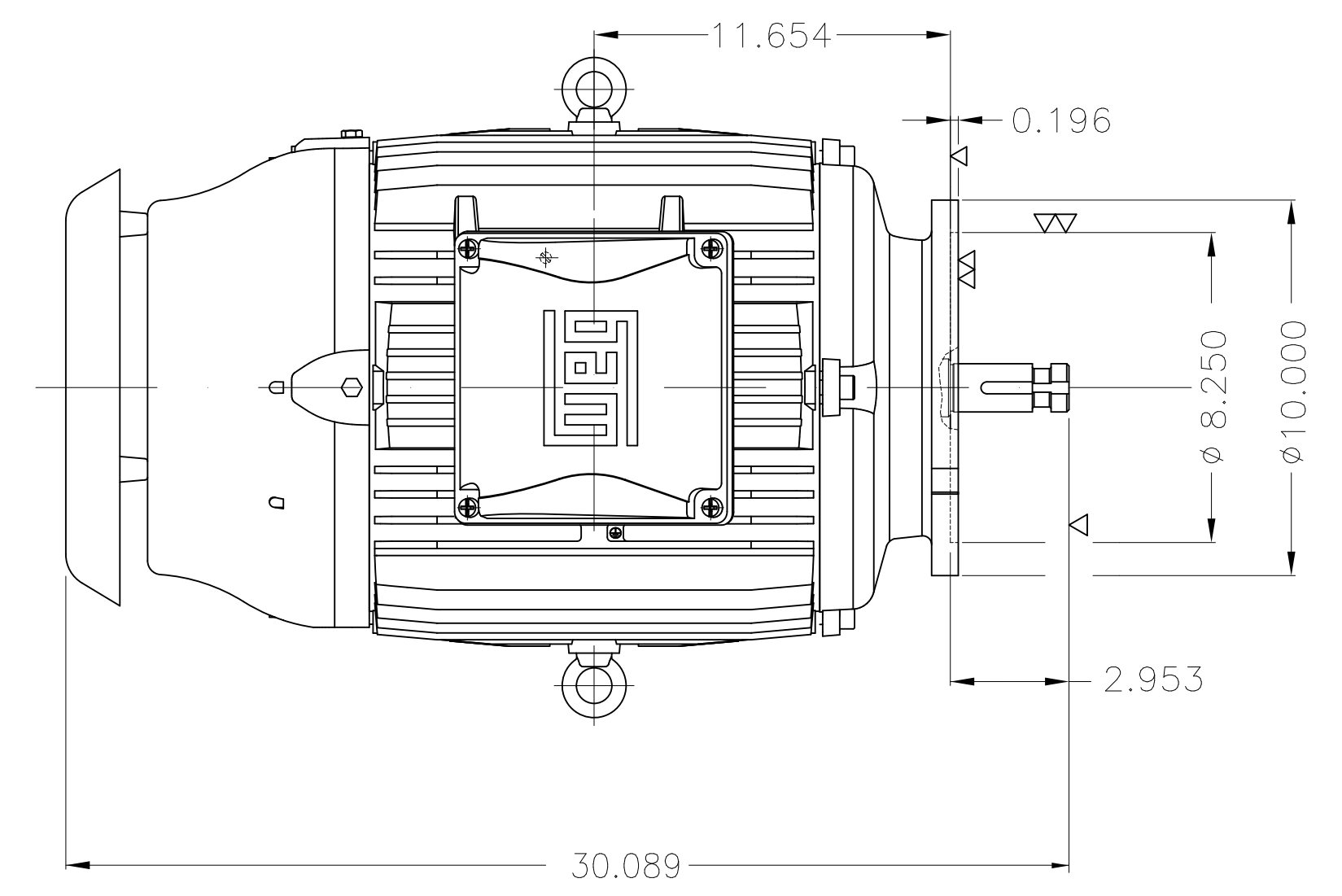
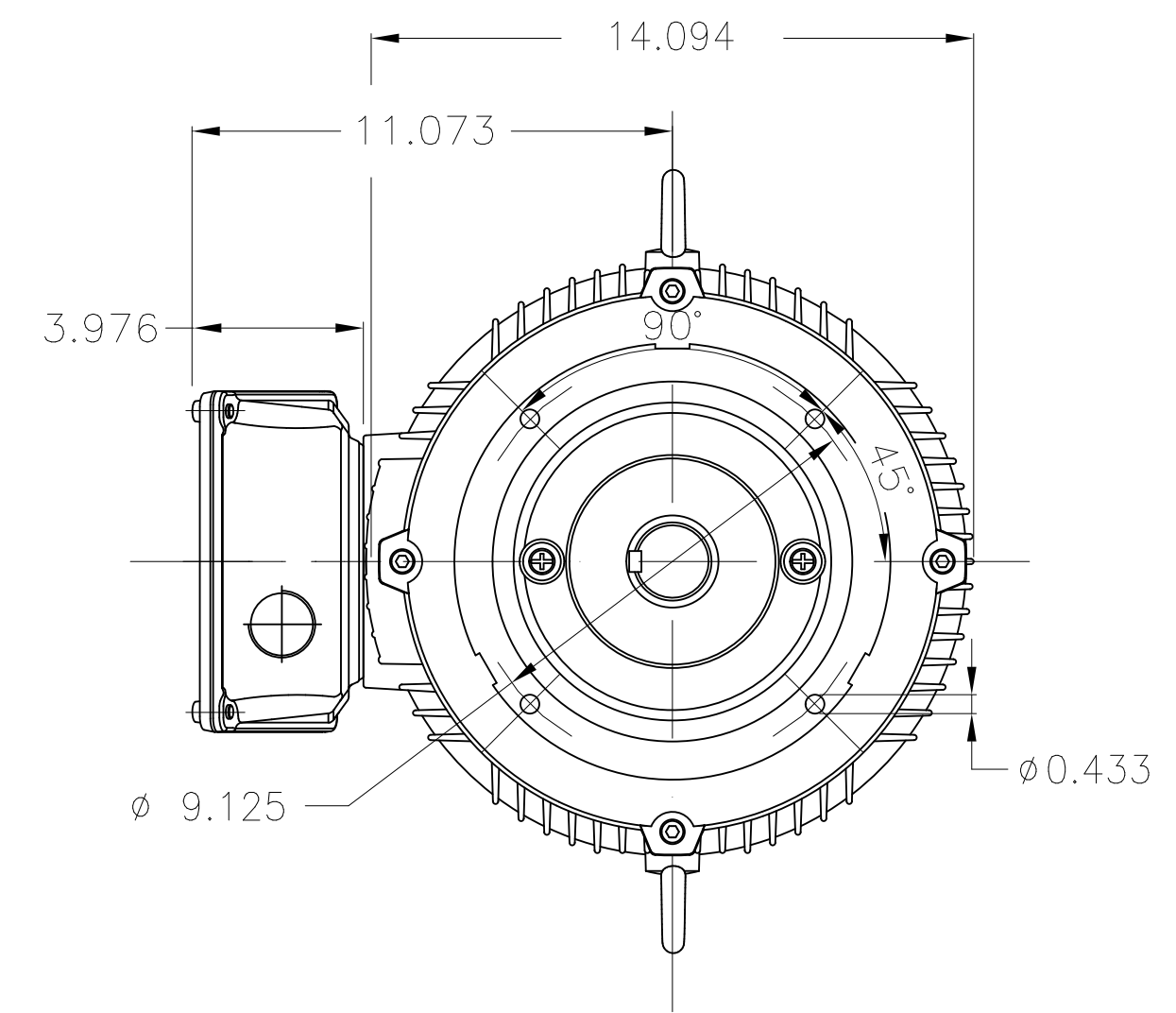

Color RAL 5009
Painting plan 203A
Mounting V1

ECM	LOC	SUMMARY OF MODIFICATIONS	EXECUTED	CHECKED	RELEASED	DATE	VER
EXECUTED	USERADMIN	THREE PHASE W22 P-BASE MOTOR PREMIUM EFF					
CHECKED		FRAME 286HP IP55 TEFC					
RELEASED		WEG code: 13016593					
REL DT	24.07.2017	WMO Jaragua do Sul	Product Engineering	SHEET	1 / 1		



30 HP 04 Poles 60Hz