

Dimensões em polegada  
Dimensions in inches

THIS IS AN UPDATED REVISION, THE  
PREVIOUS ONE MUST BE DISREGARDED.

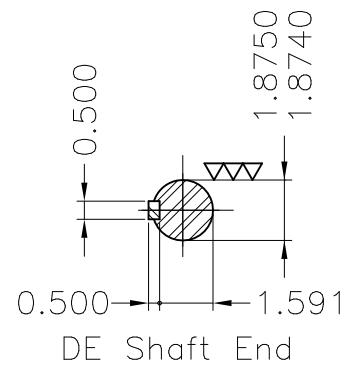
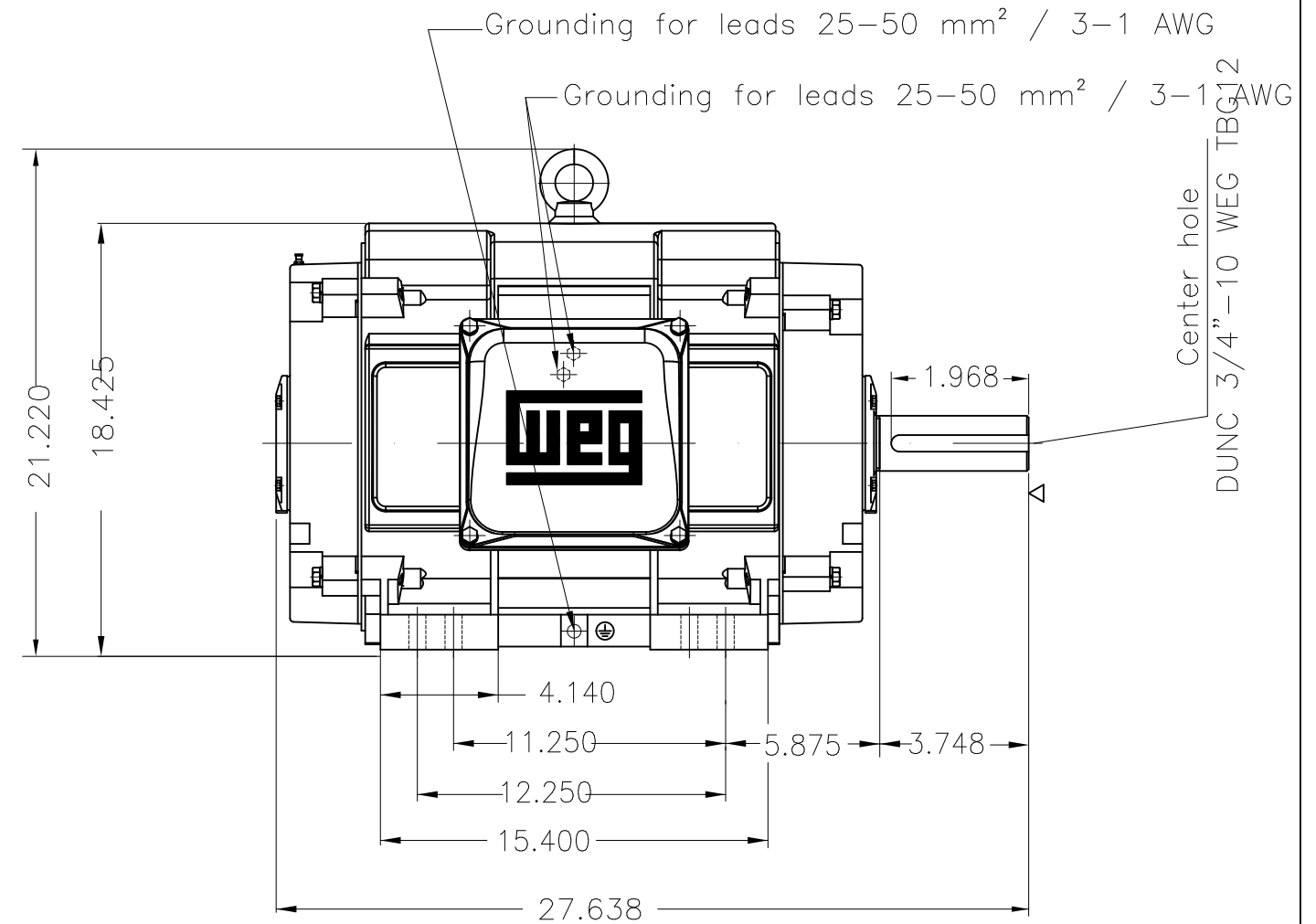
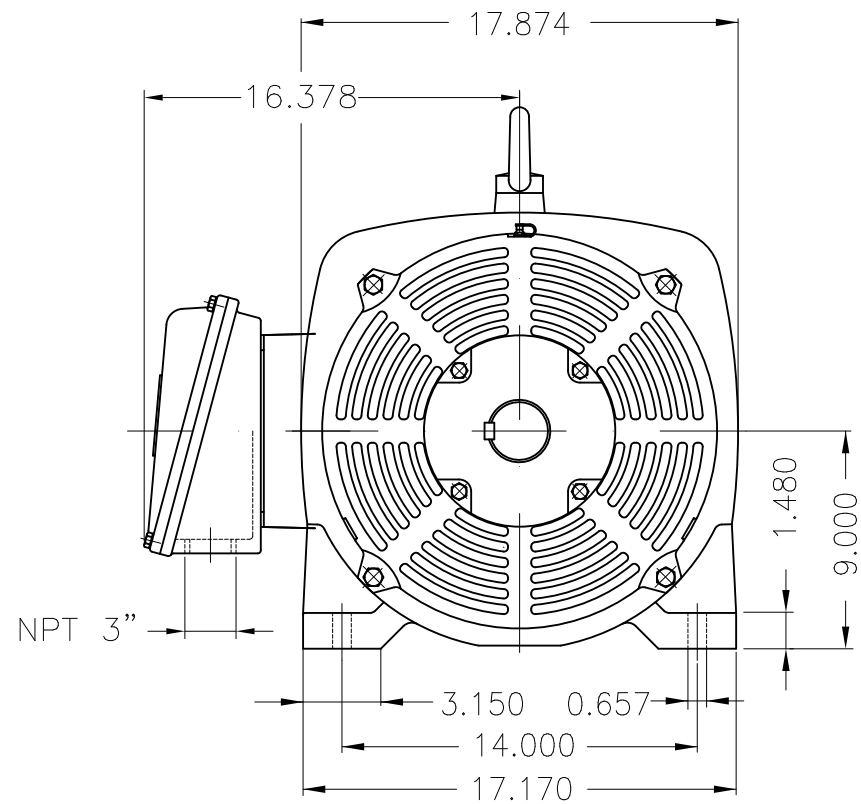

Certification UL/FIRE PUMP  
TS shaft end  
Color RAL 3002  
Painting plan 203A  
Mounting B3R(D)

ECM	LOC	SUMMARY OF MODIFICATIONS	EXECUTED	CHECKED	RELEASED	DATE	VER
EXECUTED	USERADMIN	THREE PHASE MOTOR - HIGH EFFICIENCY					
CHECKED		FRAME 364/5TS IP23 ODP					
RELEASED		WEG code: 11830174					
REL DT	24.07.2017	WMO Jaragua do Sul	Product Engineering	SHEET	1 / 1		

75 HP 04 Poles 60Hz

A

