

Dimensões em polegada  
Dimensions in inches

THIS IS AN UPDATED REVISION, THE  
PREVIOUS ONE MUST BE DISREGARDED.

Grounding for leads 5.2–35 mm<sup>2</sup> / 10–2 AWG

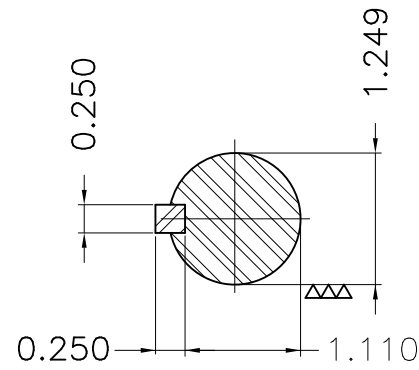
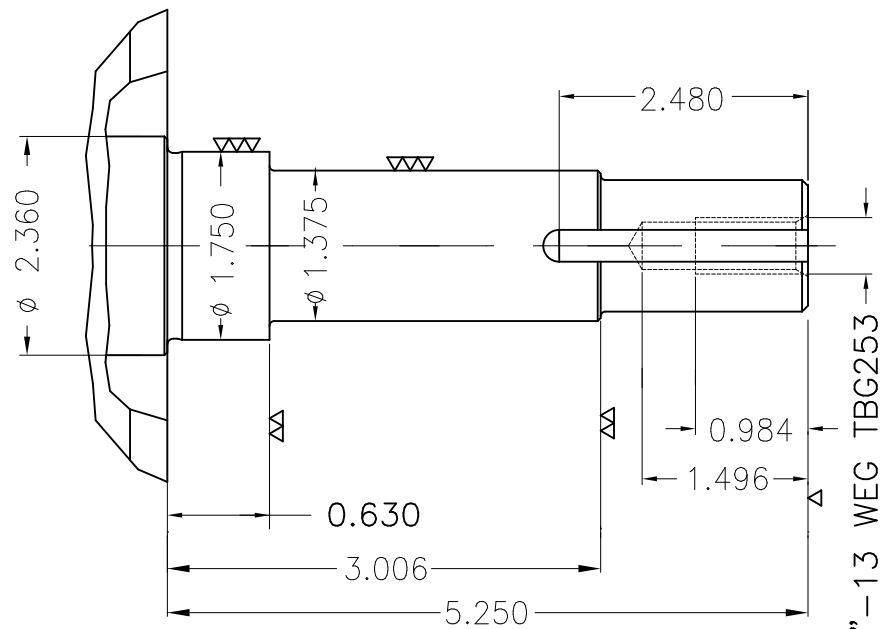
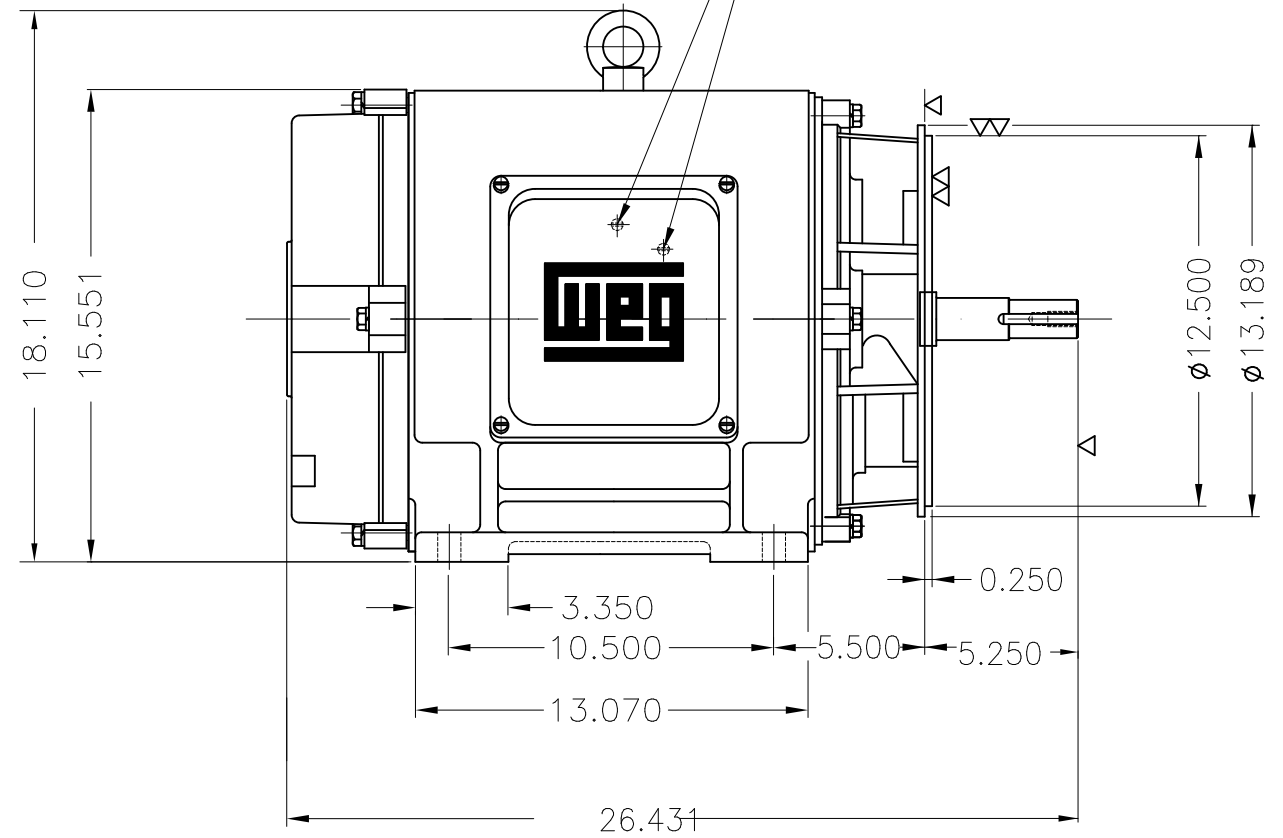
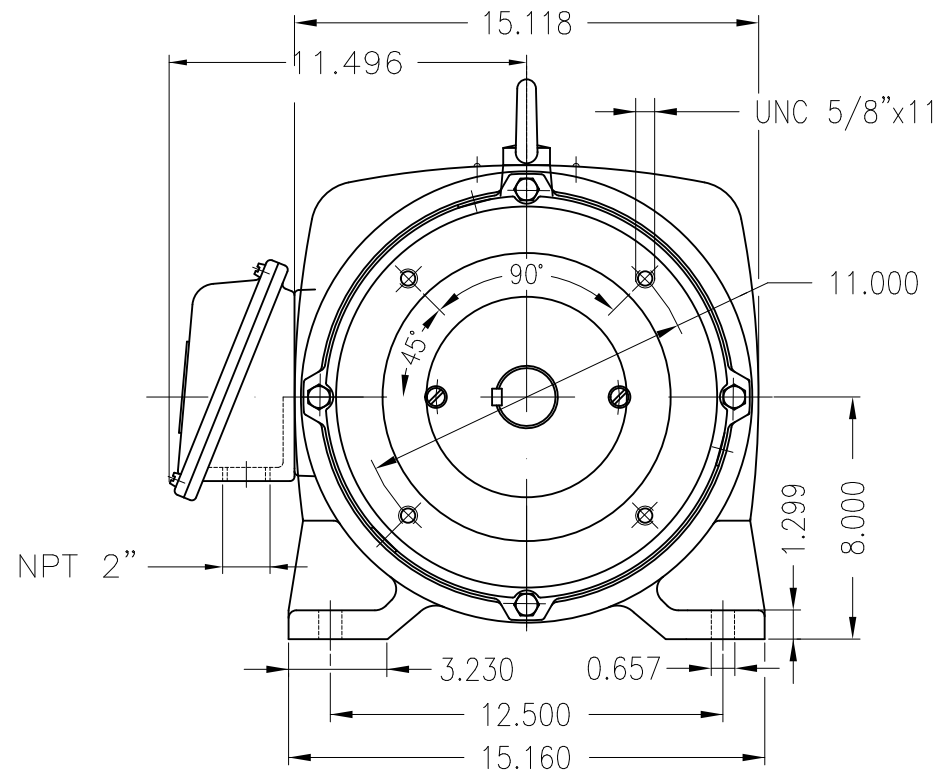

EUNC 1/2"-13 WEG TBG253

Color RAL 5009  
Painting plan 203A  
Mounting B34R(D)

ECM	LOC	SUMMARY OF MODIFICATIONS	EXECUTED	CHECKED	RELEASED	DATE	VER
EXECUTED	USERADMIN	THREE PHASE PREMIUM EFFICIENCY					
CHECKED		FRAME 324JM IP23 ODP					
RELEASED		WEG code: 11261213					
REL DT	24.07.2017	WMO Jaragua do Sul	Product Engineering	SHEET	1 / 1		

40 HP 04 Poles 60Hz

A

