

Dimensões em polegada  
Dimensions in inches

THIS IS AN UPDATED REVISION, THE  
PREVIOUS ONE MUST BE DISREGARDED.

Grounding for leads 5.2-35 mm<sup>2</sup> / 10-2 AWG

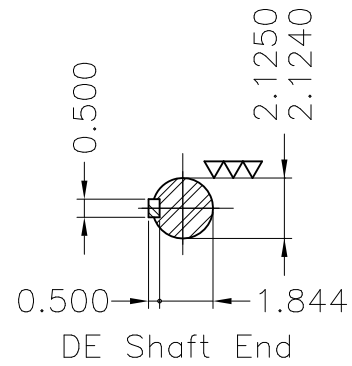
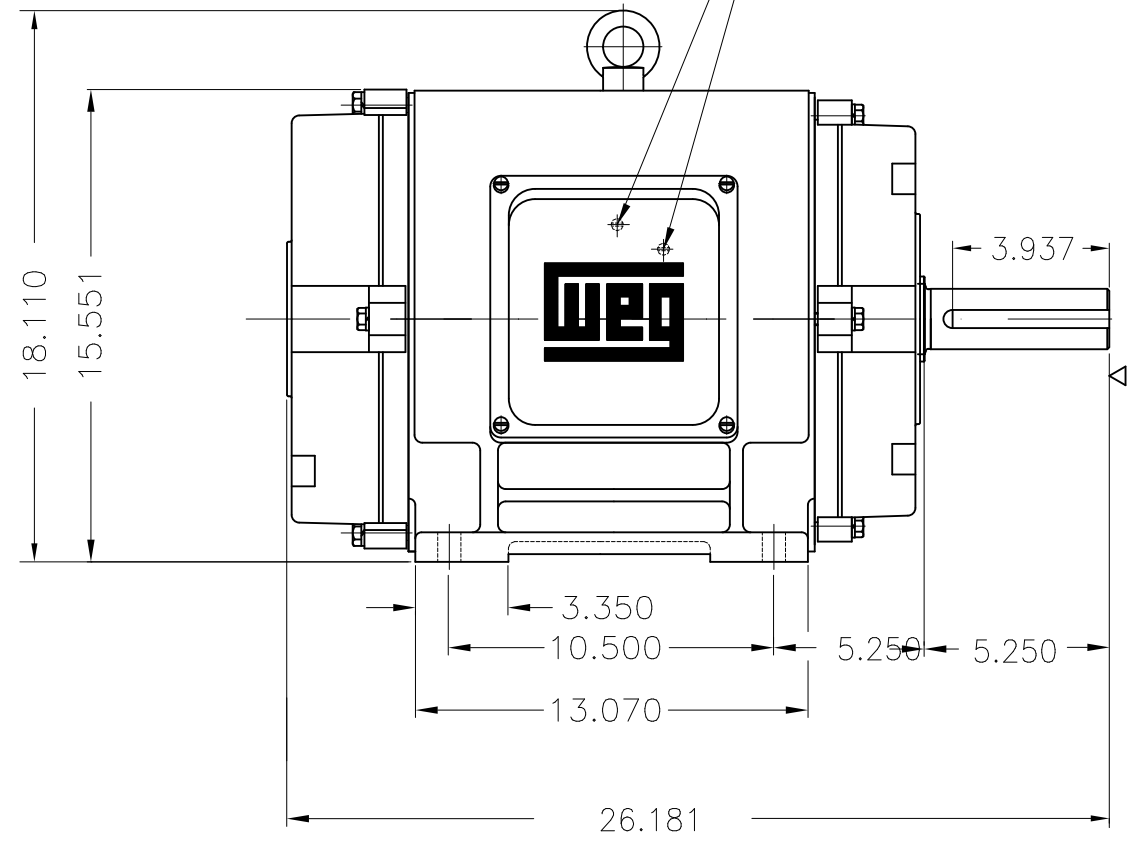
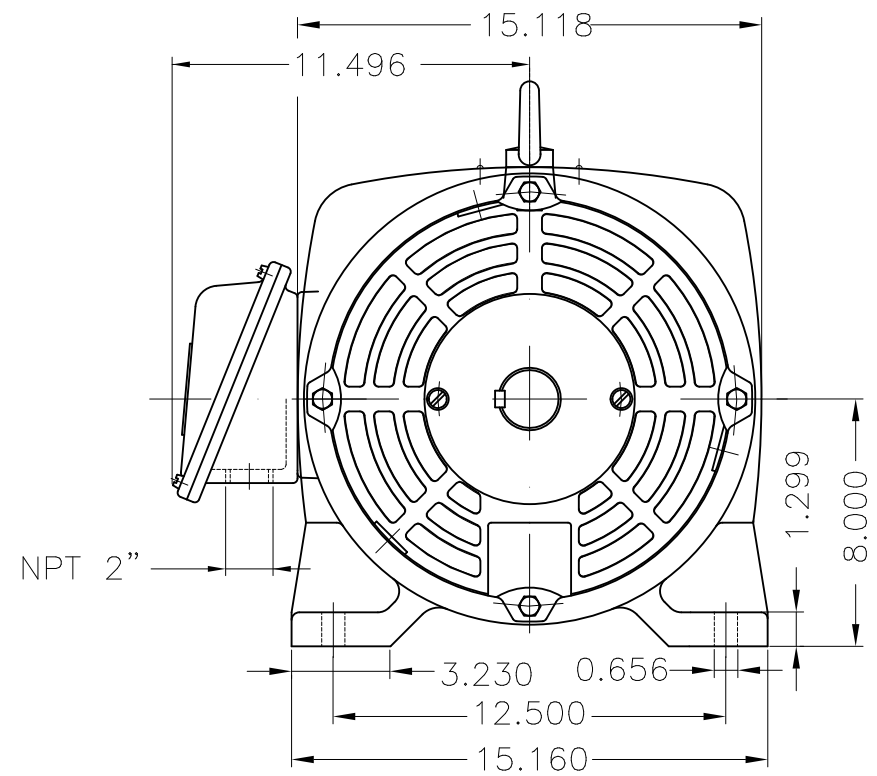

Brush holder Kit AEGIS internal DE  
Color RAL 5009  
Painting plan 203A  
Mounting B3R(D)

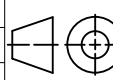
ECM	LOC	SUMMARY OF MODIFICATIONS			EXECUTED	CHECKED	RELEASED	DATE	VER
EXECUTED	USERADMIN	 THREE PHASE NEMA P. EFF MOTOR FRAME 324T IP23 ODP WEG code: 12848122							
CHECKED									
RELEASED									
REL DT	24.07.2017	WMO	Jaragua do Sul	Product Engineering	SHEET	1 / 1			

40 HP 04 Poles 60Hz

A

