

Dimensional Drawing

Catalogue	Model	HP	Pole	kW	Rating	Voltage	Hz	RPM
APH4508-841	AEHH8B	450	8	336	Continuous	460 V	60	900

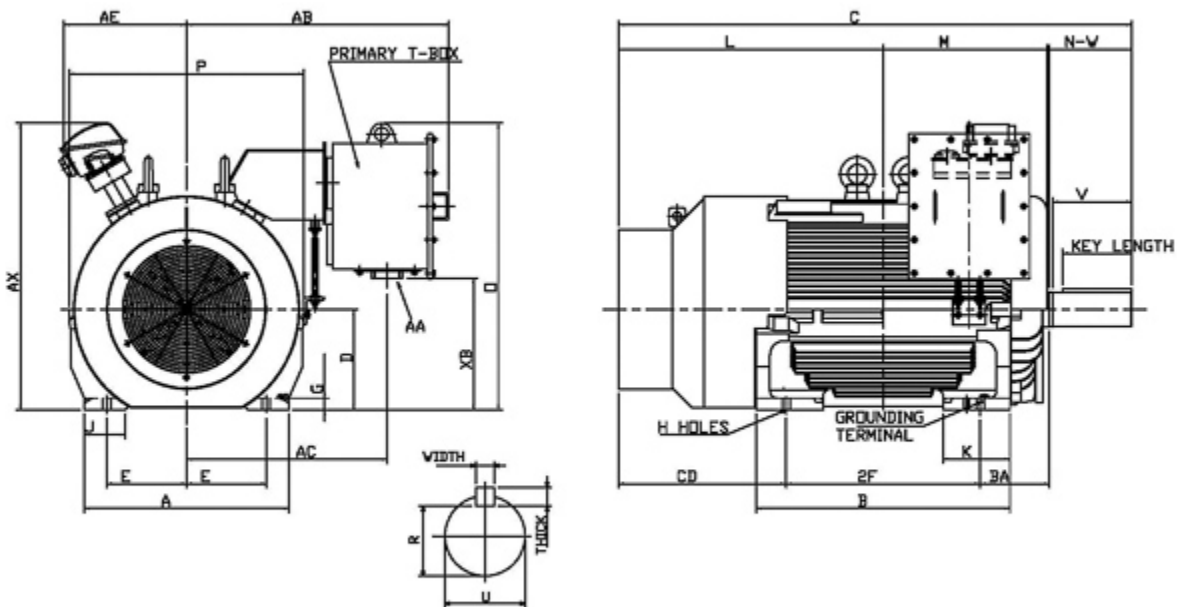

Frame Size	Mounting					A	B	C	CD	D	
	E	2F	2F2	H	BA						
5808B	11.5	28		1.13	10	29.55	36.6	74.08		14.5	
G	J	K	L	M	O	P	T	Key			Keyseat
								Width	Thick	Length	R
1.7	5.9	9.65	38.2	23.4	31.45	33.85	16.65	1.25	1.25	10	4.169
Terminal Housing				Aux Box		C/D Flange					
AA	AB	AC	XB	AE	AX	BB	AH	AK	BD	AJ	BF
	37.86	28.96	19.03	18.34	41.39						
Shaft Extension			Bearings		Approx. Weight Lbs	SPL dBA/3ft	Ins. Class	S.F.	Drive Method	Dimensions	
N-W	U	V	DE	NDE							
11.88	4.875	11.38	6326C3	6322C3	6006	80	F	1.15	Direct Coupling	Inches	

Technical Data Sheet

Motor Type: AEHH8B

Catalogue No: APH4508-841

Nameplate Information

HP	Pole	RPM	Frame	Voltage	Hz	Phase
450	8	890	5808B	460	60	3
Enclosure	Ins. Class	Service Factor	Time Rating	NEMA Design	Rated Amb.	Rated Altitude
TEFC	F	1.15	Continuous	B	-40 to 40 °C	<3300 ft

Typical Performance

Efficiency (%)				Power Factor (%)		
Full Load		3/4 Load	1/2 Load	Full Load	3/4 Load	1/2 Load
Nom.	Min.					
94.5	93.6	94.8	93.6	82.5	80.0	71.0
Torque				Current (A)		
Full Load (lb-ft)	Locked Rotor (% FLT)	Pull Up (% FLT)	Break Down (% FLT)	No Load	Full Load	Locked Rotor
2654.49	90	90	200	184.0	540.5	3250
NEMA KVA Code	Inertia (WR ²)			Safe Stall Time (s)		Noise Level Sound Press. dB(A)
	Rotor (lb-ft ²)	NEMA Load (lb-ft ²)	Max. Allowable (lb-ft ²)	Cold	Hot	
0	582.000	9456	18912	22	17	80

VFD Duty Information

Speed Range			VFD		S.F.
Constant Torque	Variable Torque	Constant Power	Carrier	Type	
20-60Hz	3-60Hz	60-60Hz	≤ 5 kHz	VPWM or CPWM	0

Additional Information

Bearings		Approx. Weight
DE	NDE	lbs
6326C3	6322C3	6006

Hazardous Locations Information

CSA Certified	
Class I, Div 2, Groups B, C & D Class I, Zone 2, Groups IIB+H2, IIB & IIA	
Temp Code (Sinewave / VFD)	T3 / T3