

Dimensões em polegada
Dimensions in inches

THIS IS AN UPDATED REVISION, THE
PREVIOUS ONE MUST BE DISREGARDED.

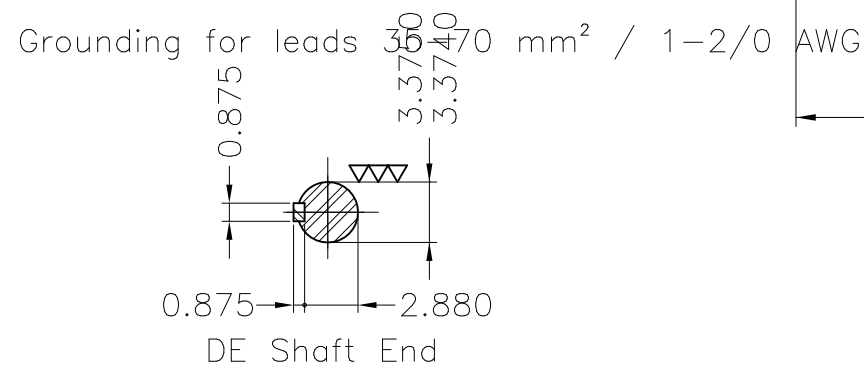
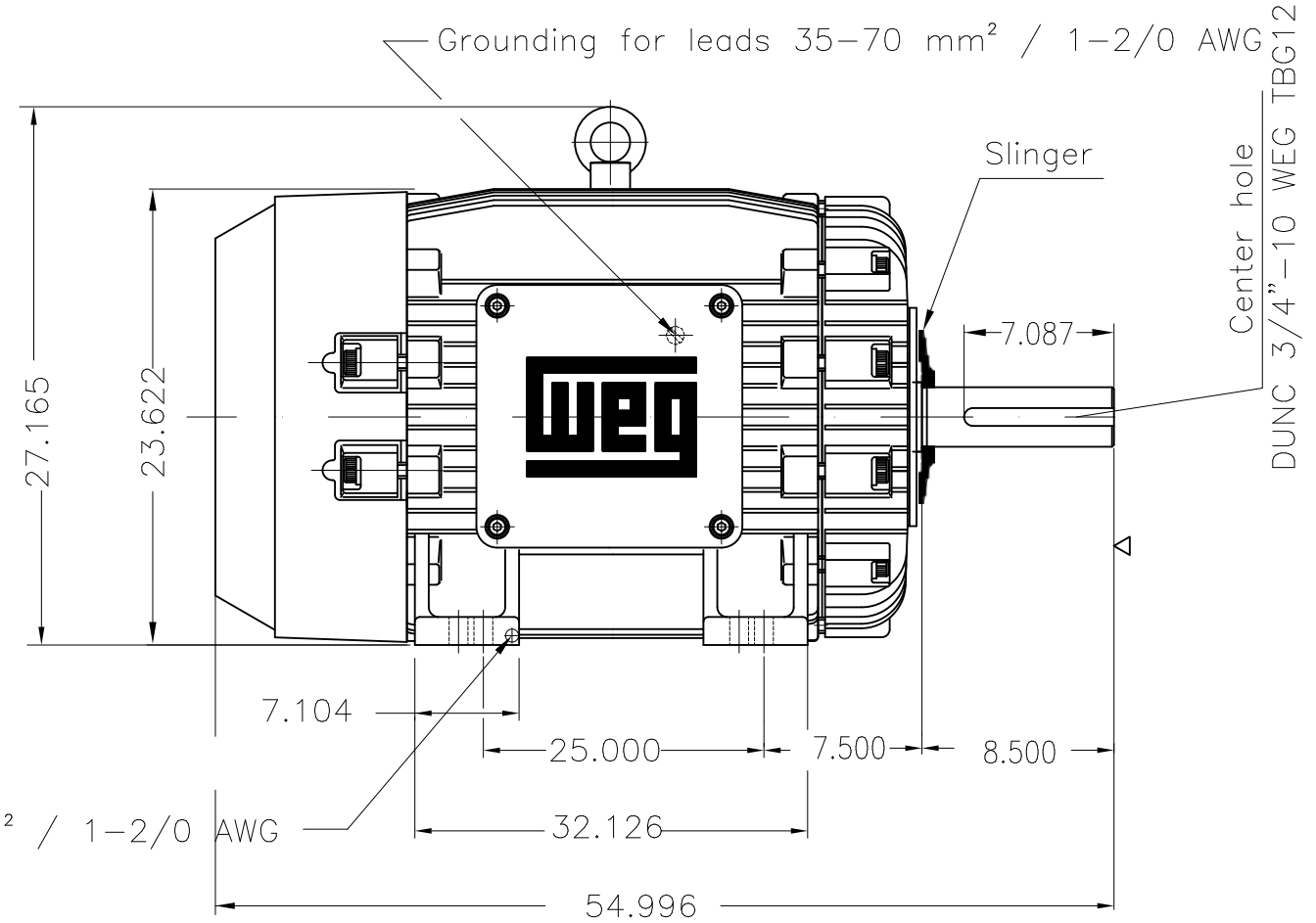
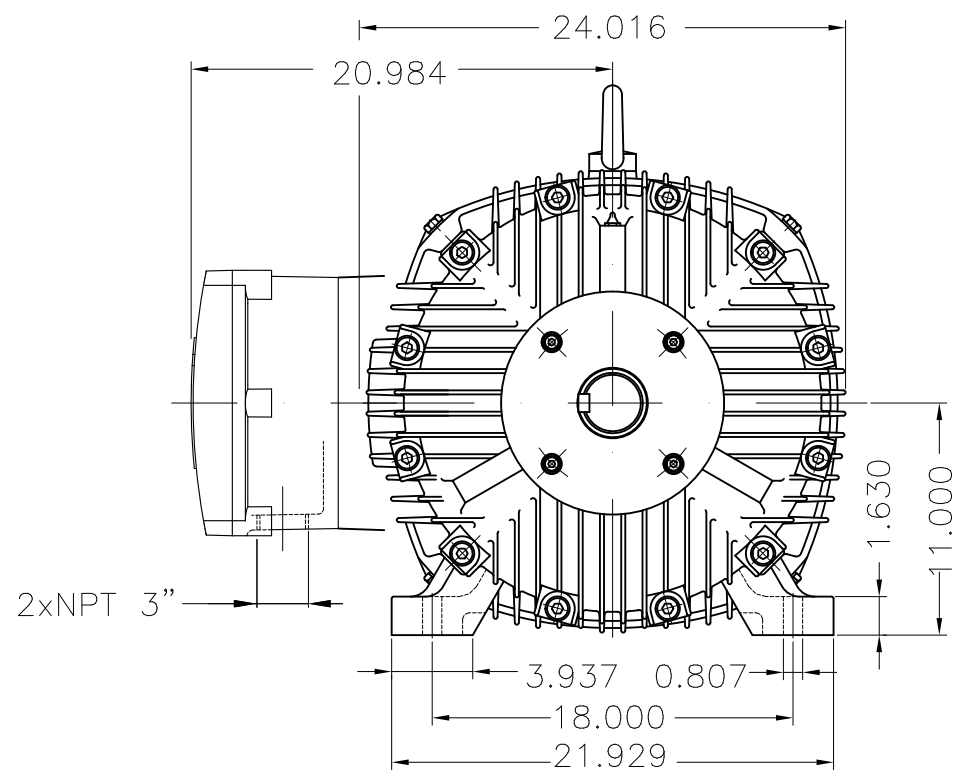

Color RAL 5009
Painting plan 202P
Mounting B3R(D)

ECM	LOC	SUMMARY OF MODIFICATIONS	EXECUTED	CHECKED	RELEASED	DATE	VER
EXECUTED	USERADMIN	THREE PHASE EXPL. PROOF MOTOR NEMA P.EFF					
CHECKED		FRAME 449T IP55 TEFC					
RELEASED		WEG code: 12408383					
REL DT	24.07.2017	WMO Jaragua do Sul	Product Engineering	SHEET	1 / 1		

300 HP 04 Poles 60Hz

A

