

Dimensões em polegada
Dimensions in inches

THIS IS AN UPDATED REVISION, THE
PREVIOUS ONE MUST BE DISREGARDED.

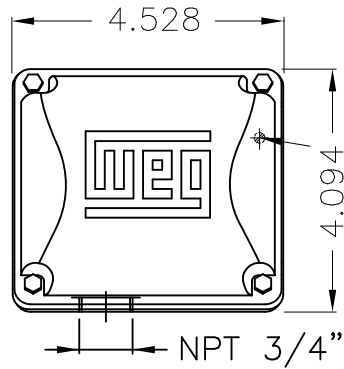

Main terminal box

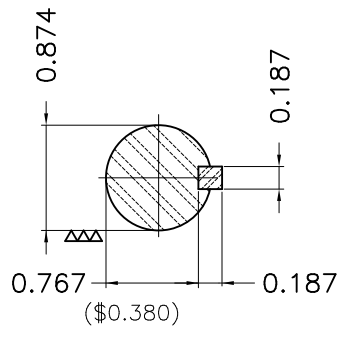
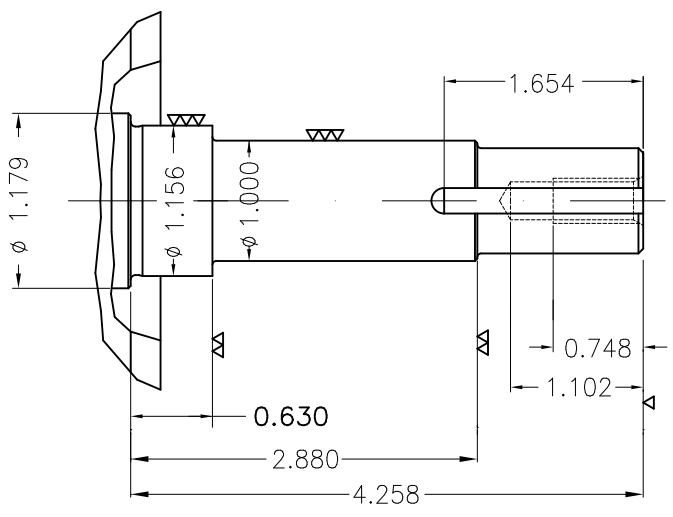
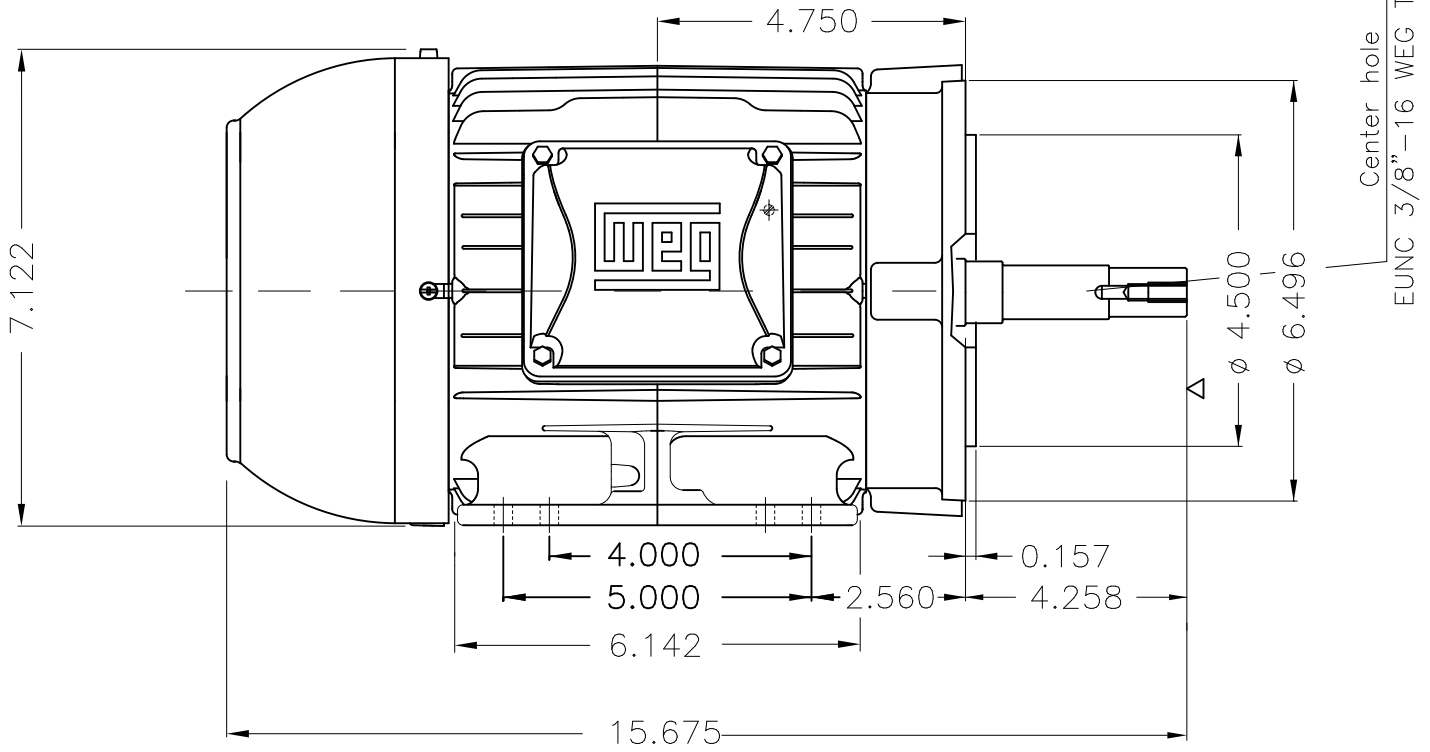
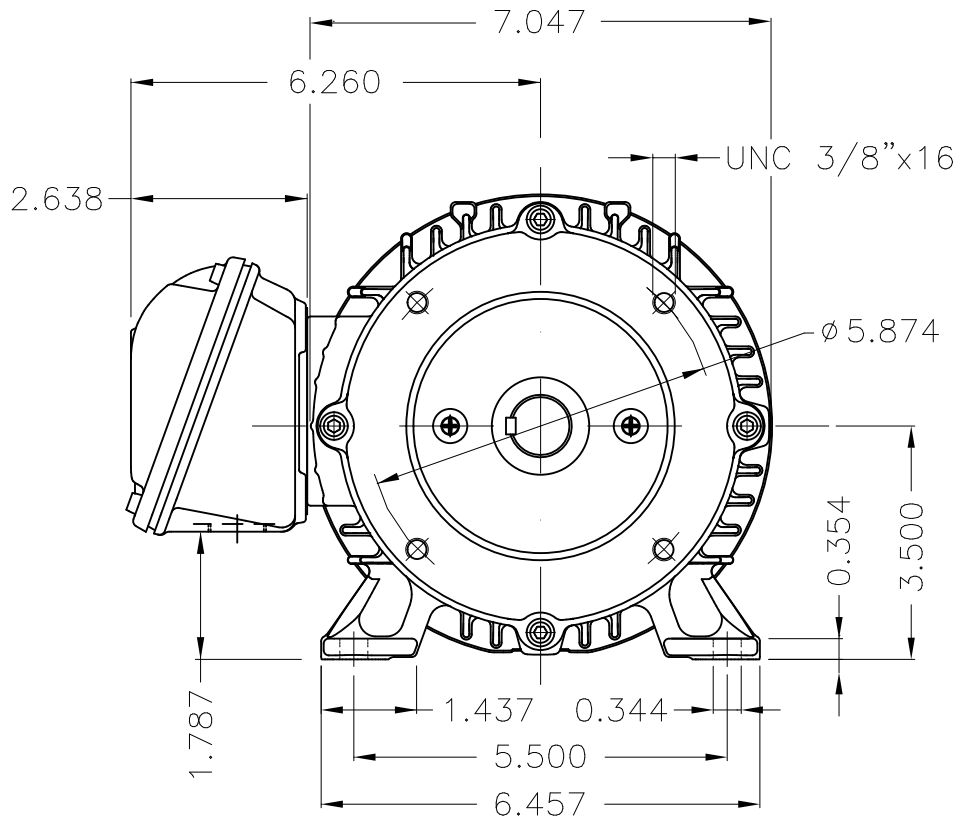

Color RAL 5009
Painting plan 207A
Mounting B34R(D)

ECM	LOC	SUMMARY OF MODIFICATIONS	EXECUTED	CHECKED	RELEASED	DATE	VER
EXECUTED	USERADMIN	THREE PHASE MOTOR W22 NEMA PREMIUM EFF.					
CHECKED		FRAME 143/5JM IP55 TEFC					
RELEASED		WEG code: 11554522					
REL DT	24.07.2017	WMO Jaragua do Sul	Product Engineering	SHEET	1 / 1		

1.5 HP 04 Poles 60Hz

