

DATE
FEBRUARY 23, 2007
CATALOG NO.
DHP0056

OUTLINE DIMENSIONS
3-PHASE INDUCTION MOTOR

MOTOR TYPE:
ASHH
FRAME NO. 215T

Pole	HP	KW	Hz	VOLT	Syn. Speed RPM
6	5	3.73	60	230/460	1200

Ins	Rating	Dimension in	Approx Weight	Bearings
F	CONT.	inch	185 lbs.	DE: 6308zz NDE: 6306zz

Open Protected Drip-Proof Squirrel Cage Rotor.

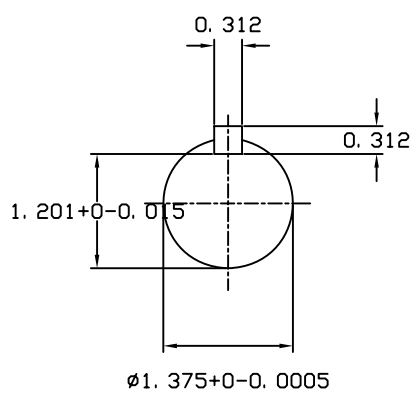
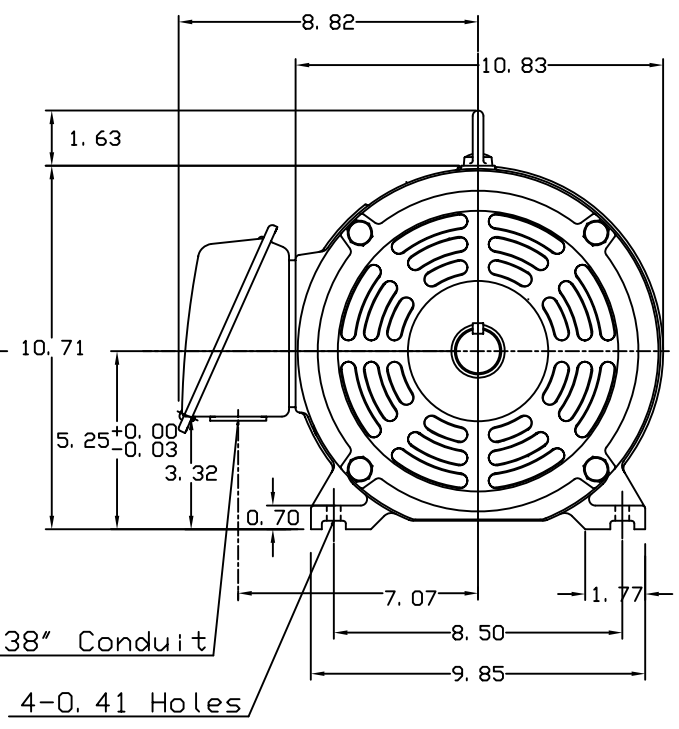
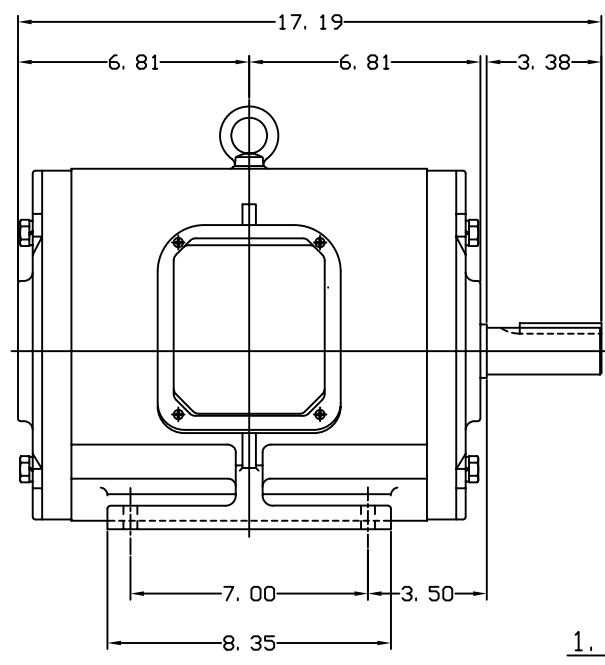

DWN.	J. H. LIANG	12-22-98
CHKD.	C. S. LO	05-20-99
APPD.	Y. B. HUANG	05-20-99



DWG NO.
31057H382000