

Dimensões em polegada
Dimensions in inches

THIS IS AN UPDATED REVISION, THE
PREVIOUS ONE MUST BE DISREGARDED.

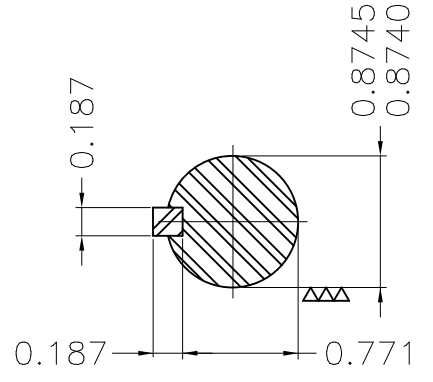
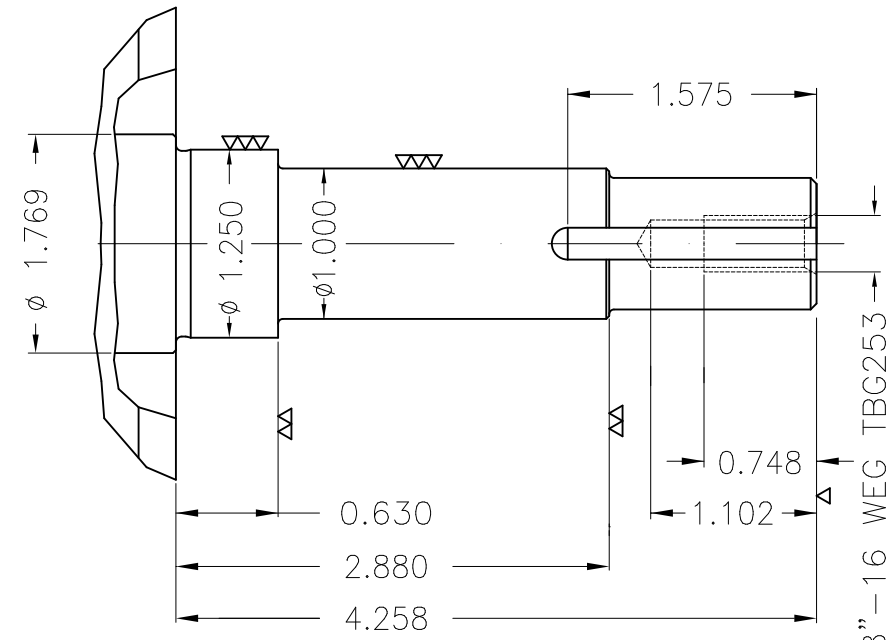
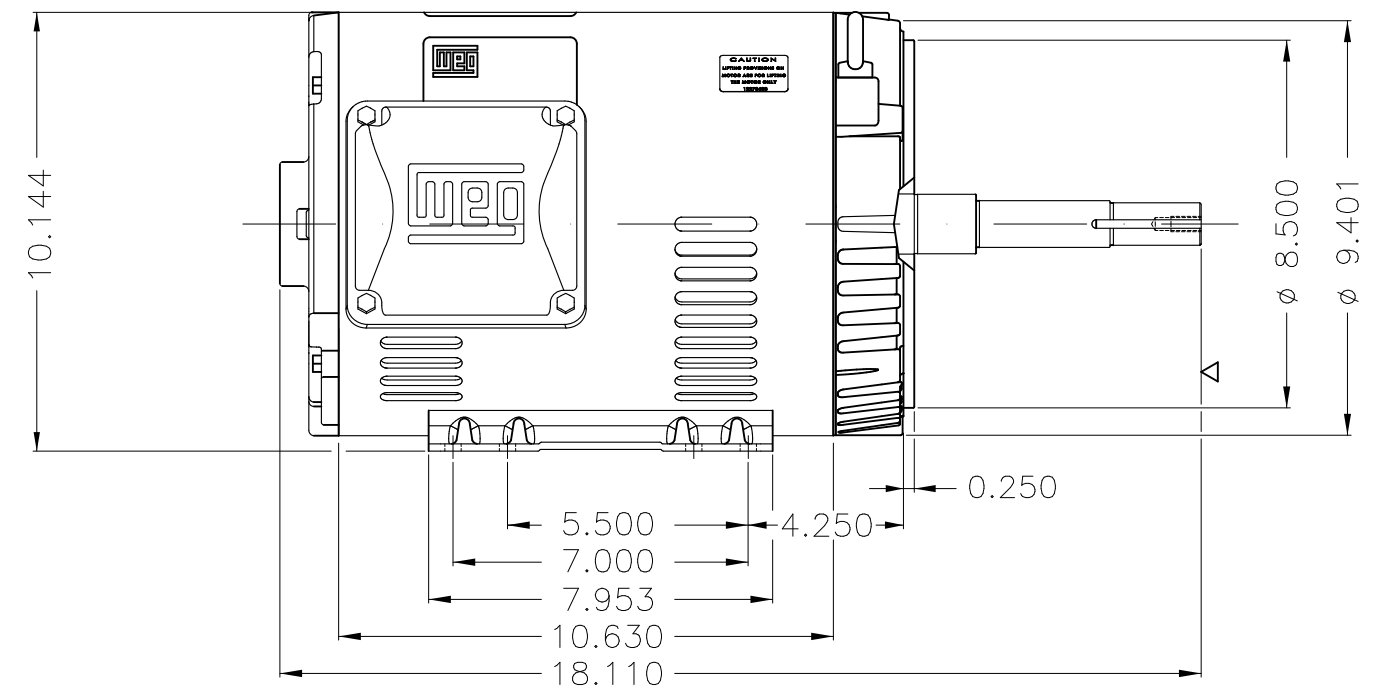
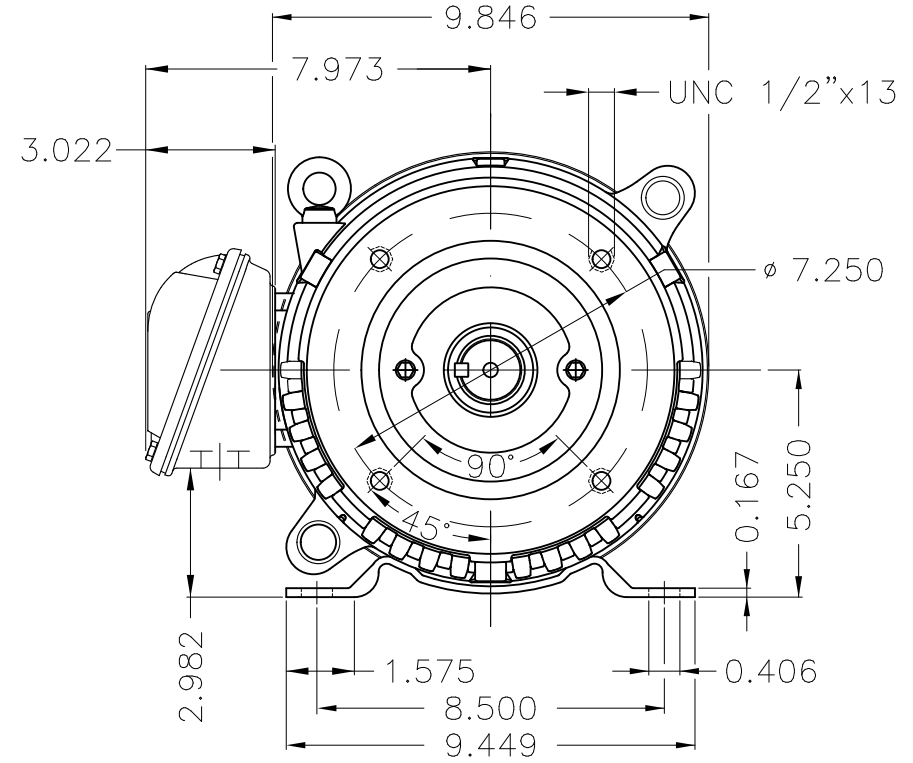
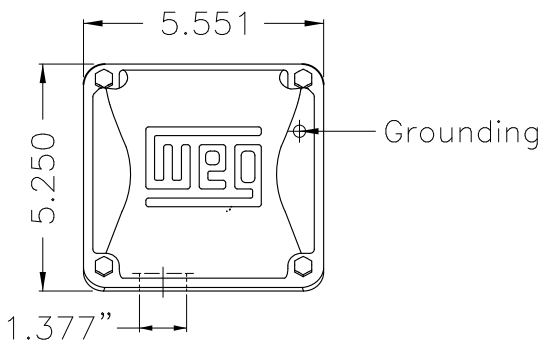

EUNC 3/8" - 16 WEG TBG253

Brush holder Kit AEGIS internal DE
Color Munsell N 1 matte black
Painting plan 207N
Mounting F-1/B34R(D)

ECM	LOC	SUMMARY OF MODIFICATIONS			EXECUTED	CHECKED	RELEASED	DATE	VER
EXECUTED	USERADMIN		THREE PHASE ODP ROLLED STEEL NEMA PREM.						
CHECKED			FRAME 213/5JM ODP						
RELEASED			WEG code: 12922413						
REL DT	24.07.2017	WMO	Jaragua do Sul	Product Engineering	SHEET	1 / 1			

10 HP 02 Poles 60Hz

