

Dimensões em polegada  
Dimensions in inches

THIS IS AN UPDATED REVISION, THE  
PREVIOUS ONE MUST BE DISREGARDED.



Grounding for leads 25–50 mm<sup>2</sup> / 3–1 AWG

Main terminal box

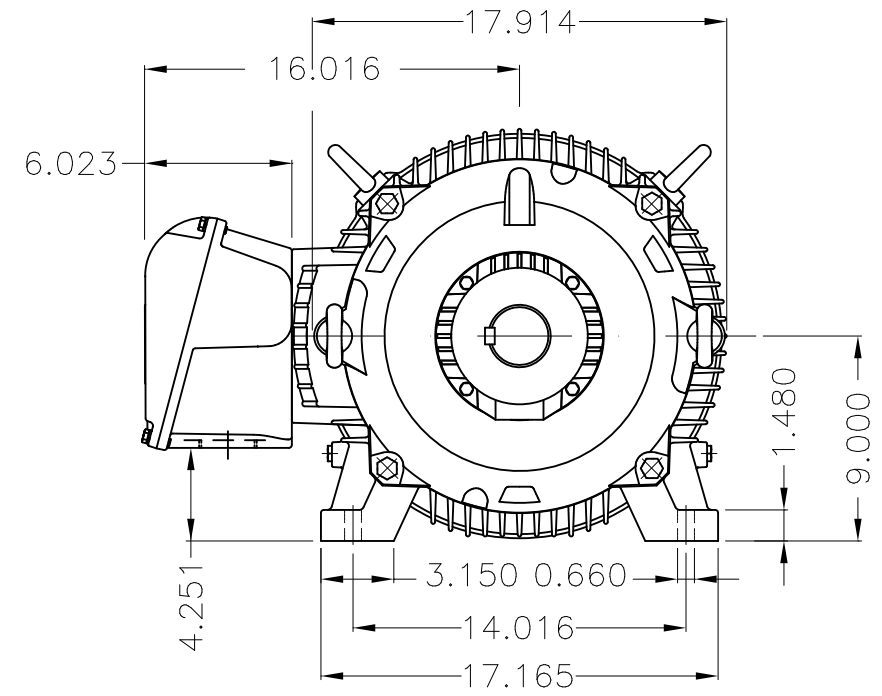

Grounding for leads 25–185 mm<sup>2</sup> / 3AWG–350MCM

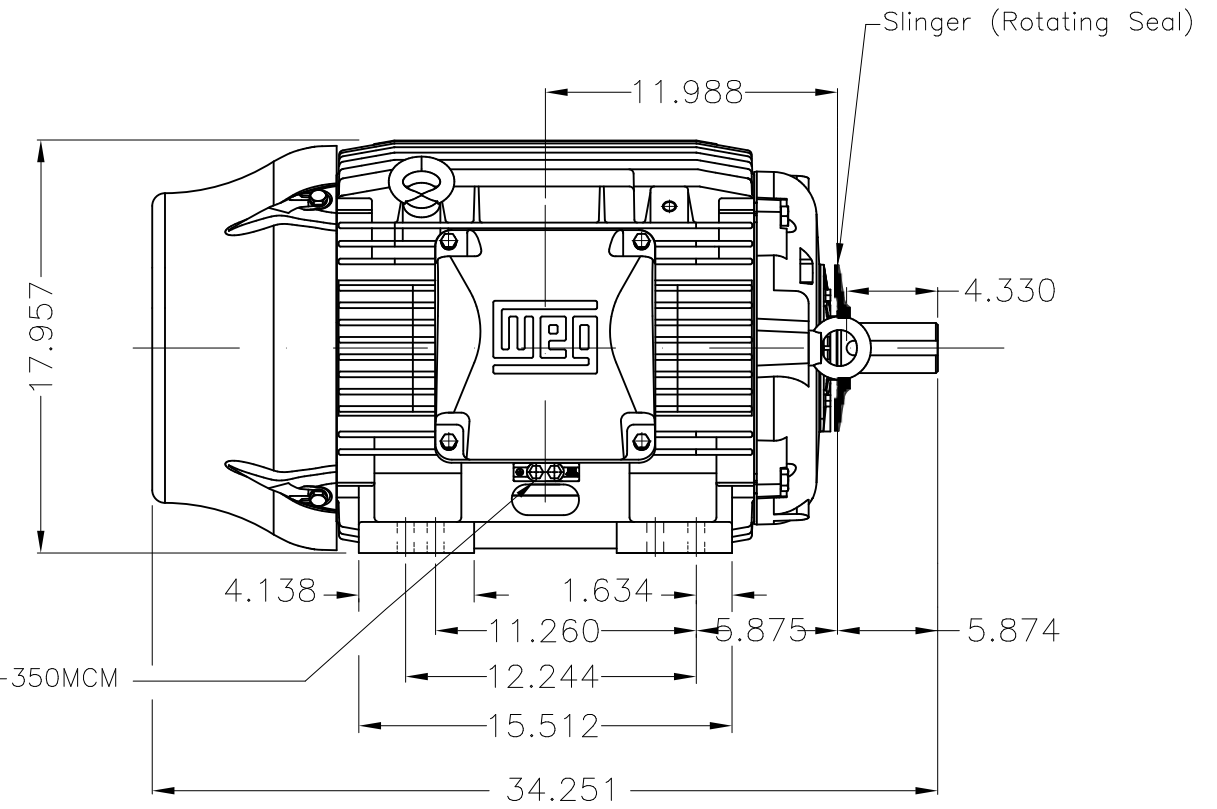

Slinger (Rotating Seal)

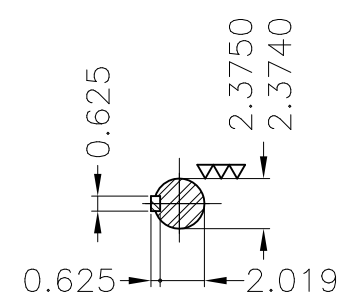

DE Shaft End

Color RAL 5009  
Painting plan 202E  
Mounting B3R(D)

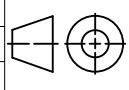
ECM	LOC	SUMMARY OF MODIFICATIONS			EXECUTED	CHECKED	RELEASED	DATE	VER
EXECUTED	USERADMIN	 THREE PH W22 MOTOR COOLING TOWER HIGH EF FRAME 364/5T IP55 TEFC WEG code: 12175363							
CHECKED									
RELEASED									
REL DT	24.07.2017	WMO	Jaragua do Sul	Product Engineering	SHEET	1 / 1			

15/60 HP 08/04 Poles 60Hz

