

DATE
February 18, 2004
CATALOG NO.
DJP0024

OUTLINE DIMENSIONS
3-PHASE INDUCTION MOTOR

MODEL TYPE:
ASGAJP
FRAME NO. 145JP

Pole	HP	kW	Hz	VOLT	Syn. Speed r/min(rpm)
4	2	1.5	60	230/460	1800

Ins	Rating	Dimension in	Approx Weight	Bearings
F	CONT.	inches	46.2 lbs.	DE: 6206ZZ NDE: 6204ZZ

Open Protected Drip-Proof Squirrel Cage Rotor.

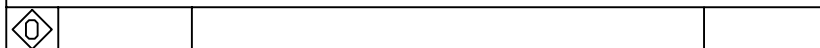
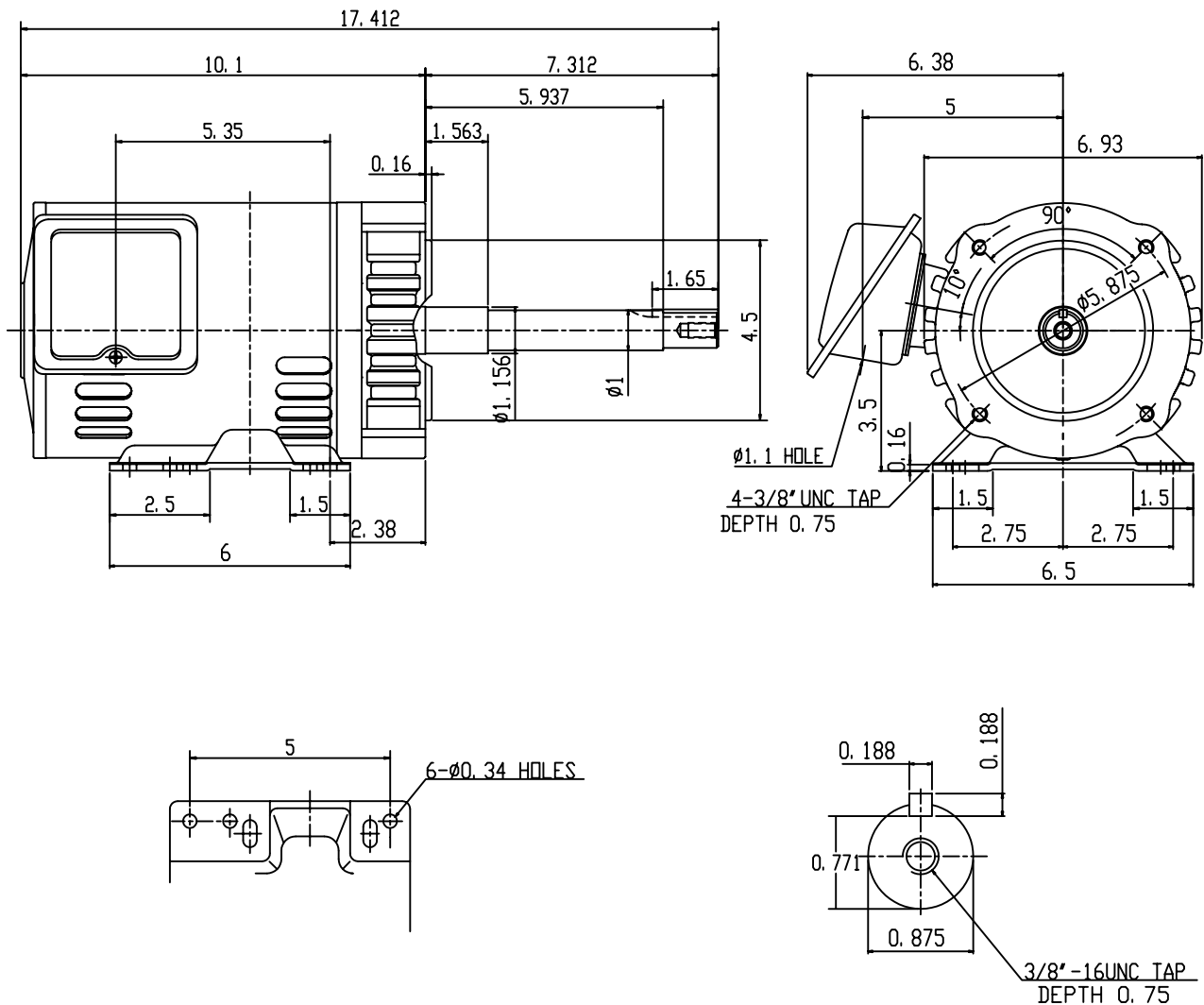

DWN.	J. T. HWANG	04-11-03
CHKD.	J. S. JEAN	04-11-03
APPD.	Y. B. HUANG	04-11-03

TECO Westinghouse

DWG NO.
31049Z105
1097