

Dimensões em polegada
Dimensions in inches

THIS IS AN UPDATED REVISION, THE
PREVIOUS ONE MUST BE DISREGARDED.

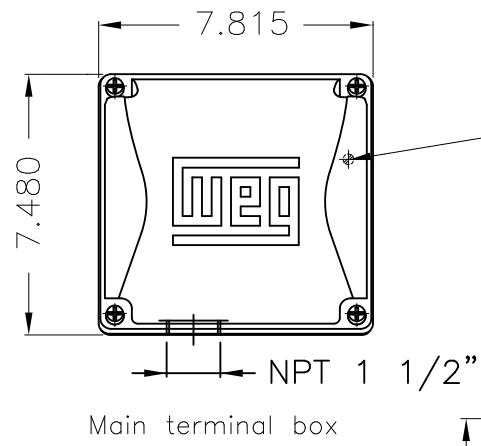

Grounding for leads 5.2–25 mm² / 10–4 AWG

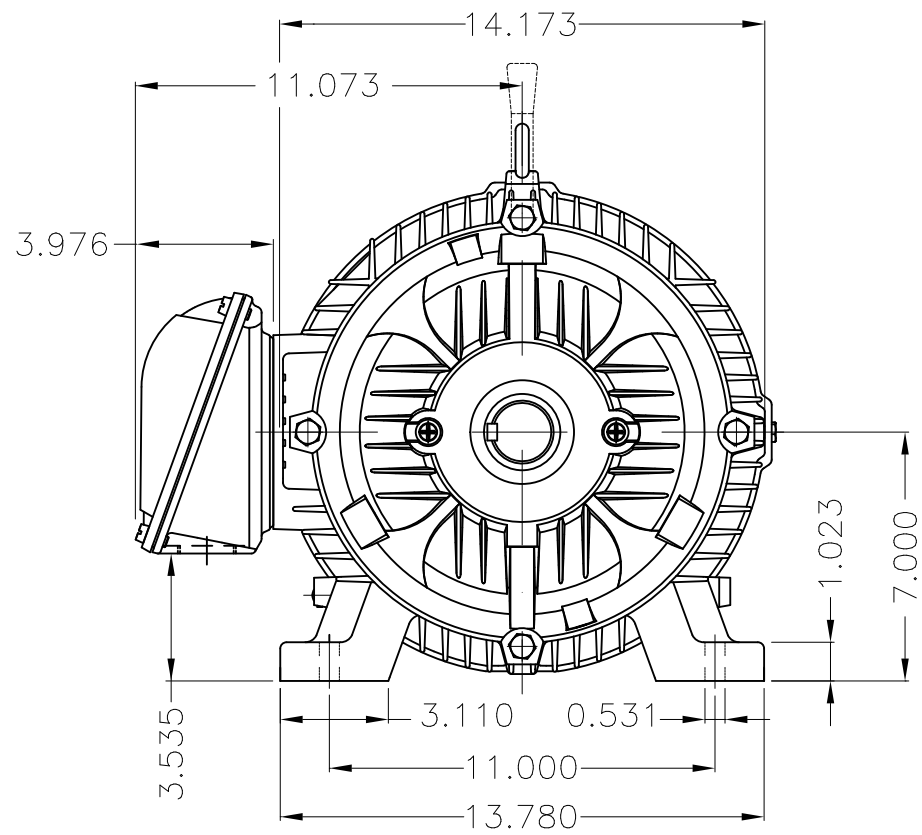
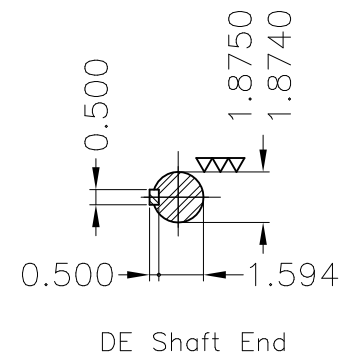
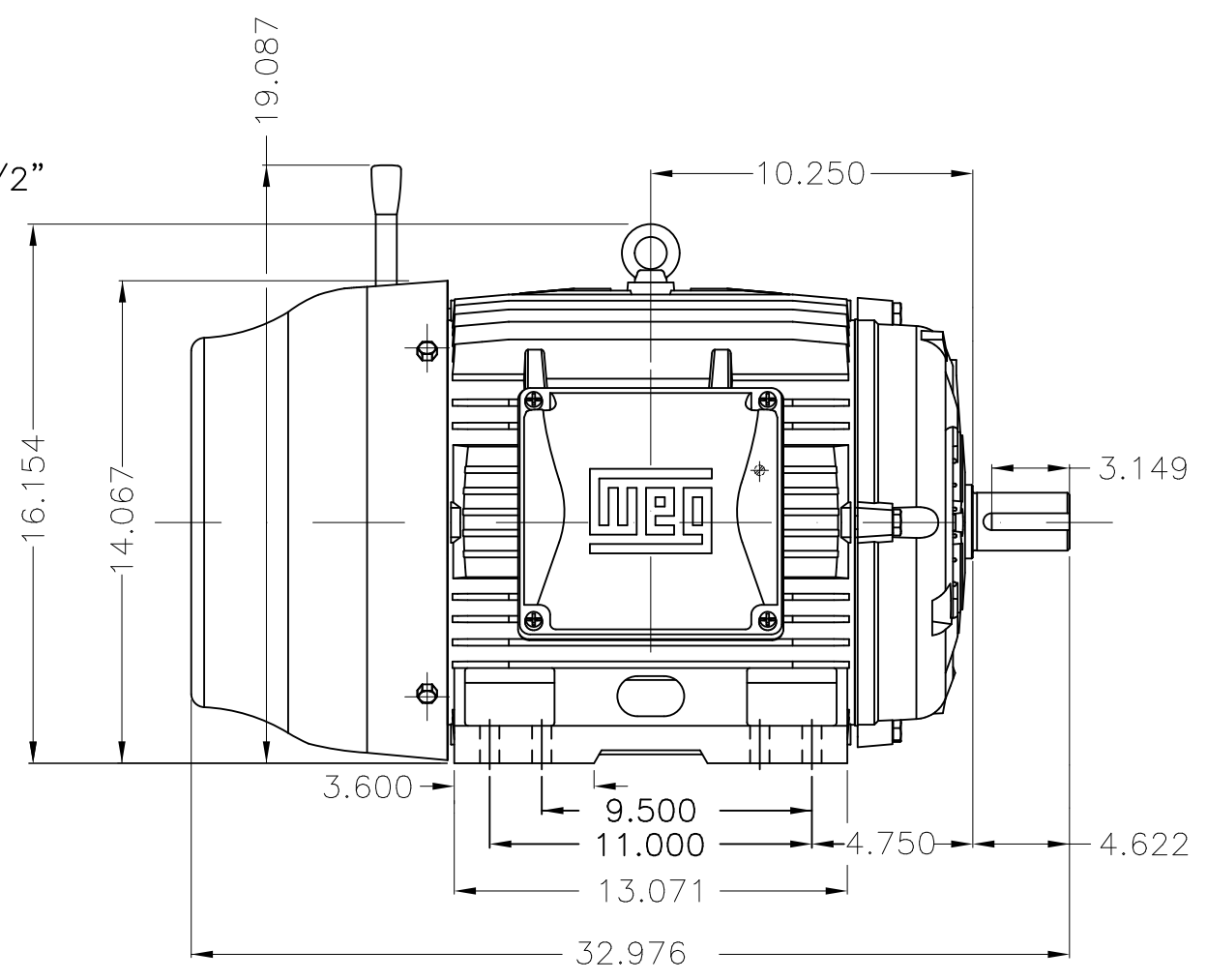

Color RAL 5009
Painting plan 203A
Mounting B3R(D)

ECM	LOC	SUMMARY OF MODIFICATIONS	EXECUTED	CHECKED	RELEASED	DATE	VER
EXECUTED	USERADMIN	W22 THREE PHASE BRAKE MOTOR - NEMA PREMIUM EFF					
CHECKED		FRAME 284/6T IP55 TEFC					
RELEASED		WEG code: 13467642					
REL DT	24.07.2017	WMO Jaragua do Sul	Product Engineering	SHEET	1 / 1		

30 HP 04 Poles 60Hz

