

Dimensões em polegada
Dimensions in inches

THIS IS AN UPDATED REVISION, THE
PREVIOUS ONE MUST BE DISREGARDED.

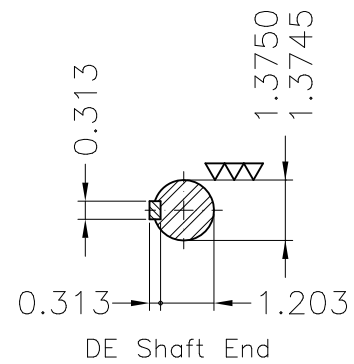
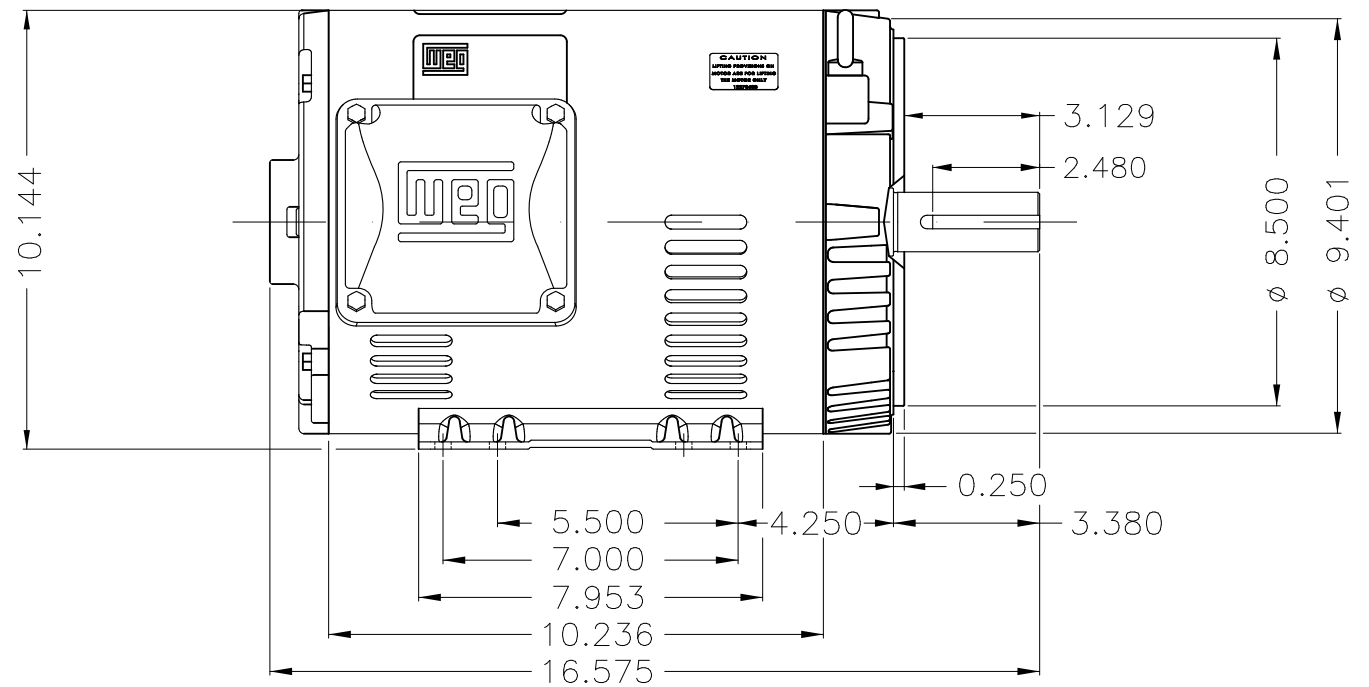
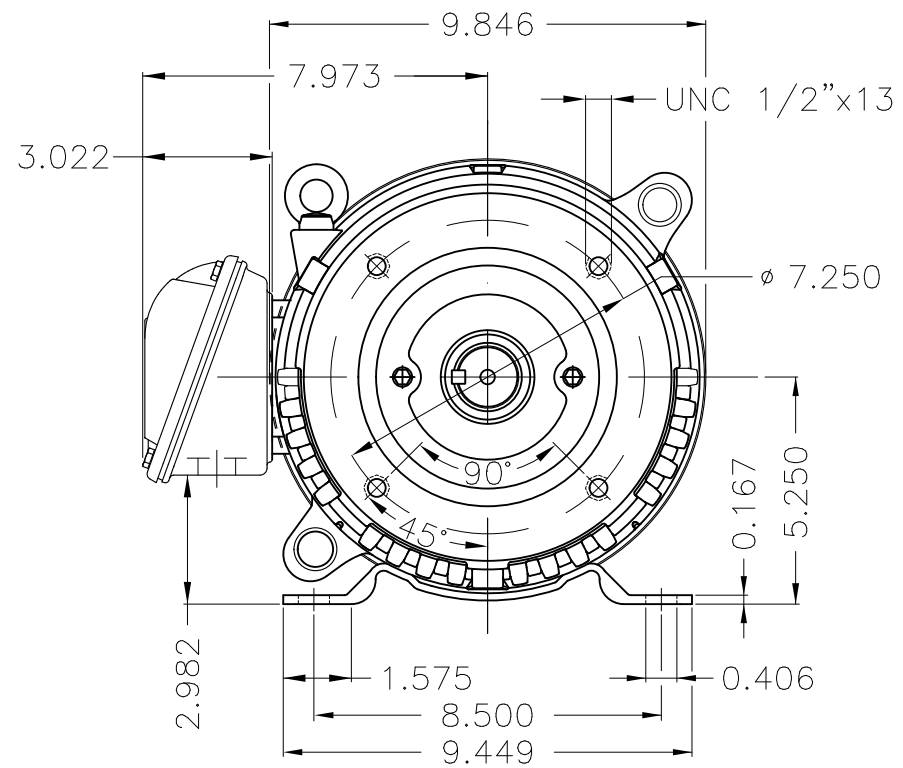
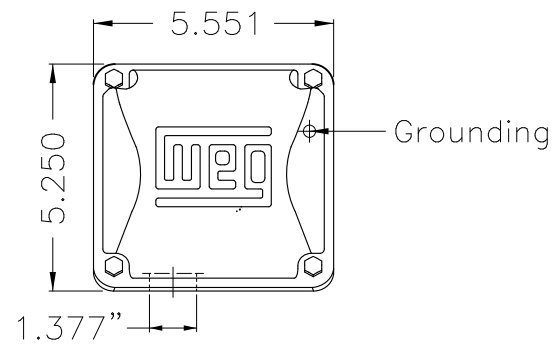

Color Munsell N 1 matte black
Painting plan 207N
Mounting F-1/B34R(D)

ECM	LOC	SUMMARY OF MODIFICATIONS	EXECUTED	CHECKED	RELEASED	DATE	VER
EXECUTED	USERADMIN	THREE PHASE ODP ROLLED STEEL NEMA PREM.					
CHECKED		FRAME 213/5TC ODP					
RELEASED		WEG code: 12651240					
REL DT	24.07.2017	WMO Jaragua do Sul	Product Engineering	SHEET	1 / 1		

7.5 HP 04 Poles 60Hz

A

