

THIS IS AN UPDATED REVISION, THE PREVIOUS ONE MUST BE DISREGARDED.

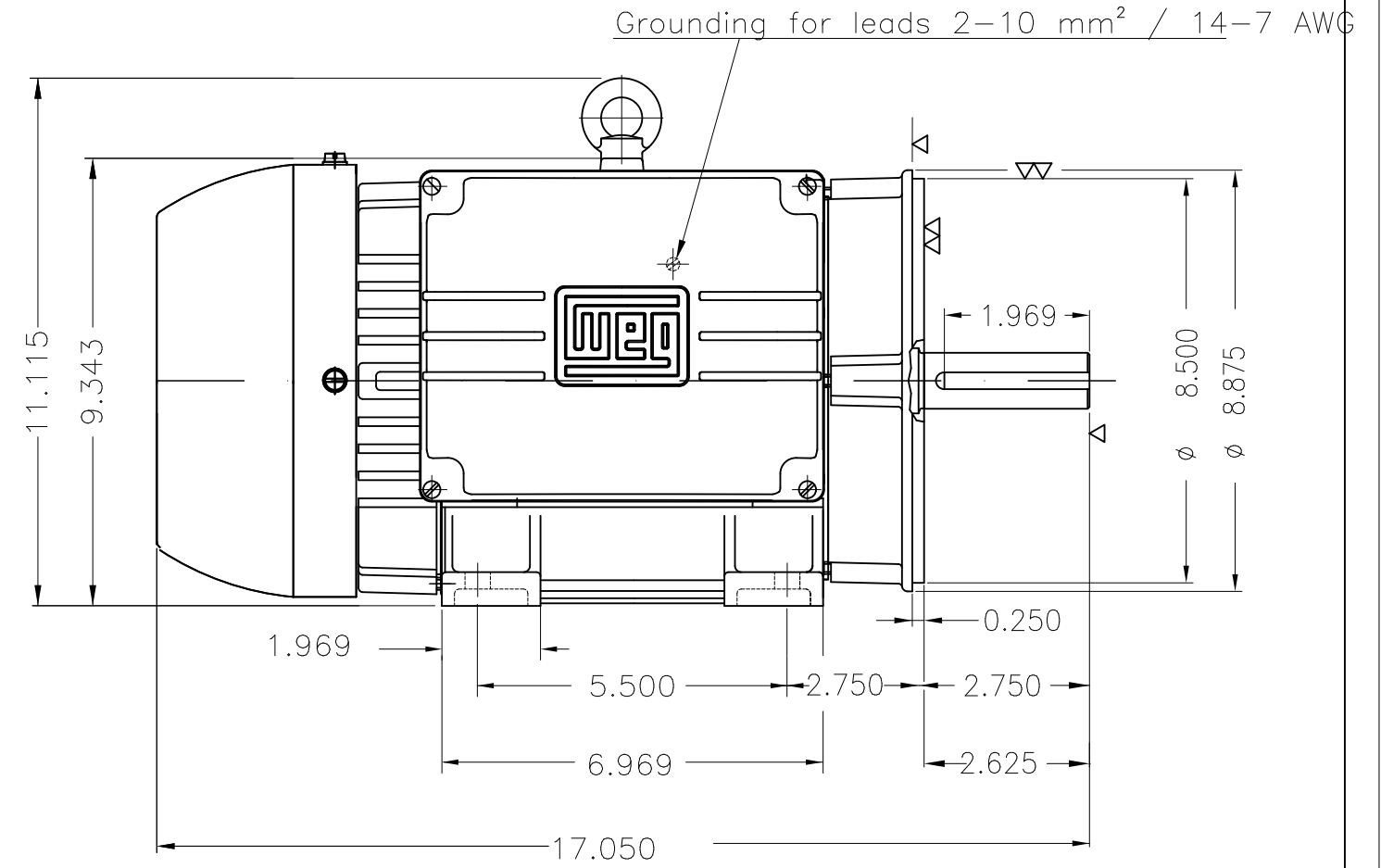
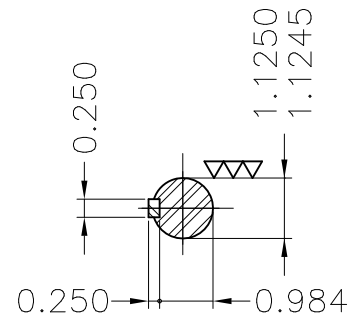
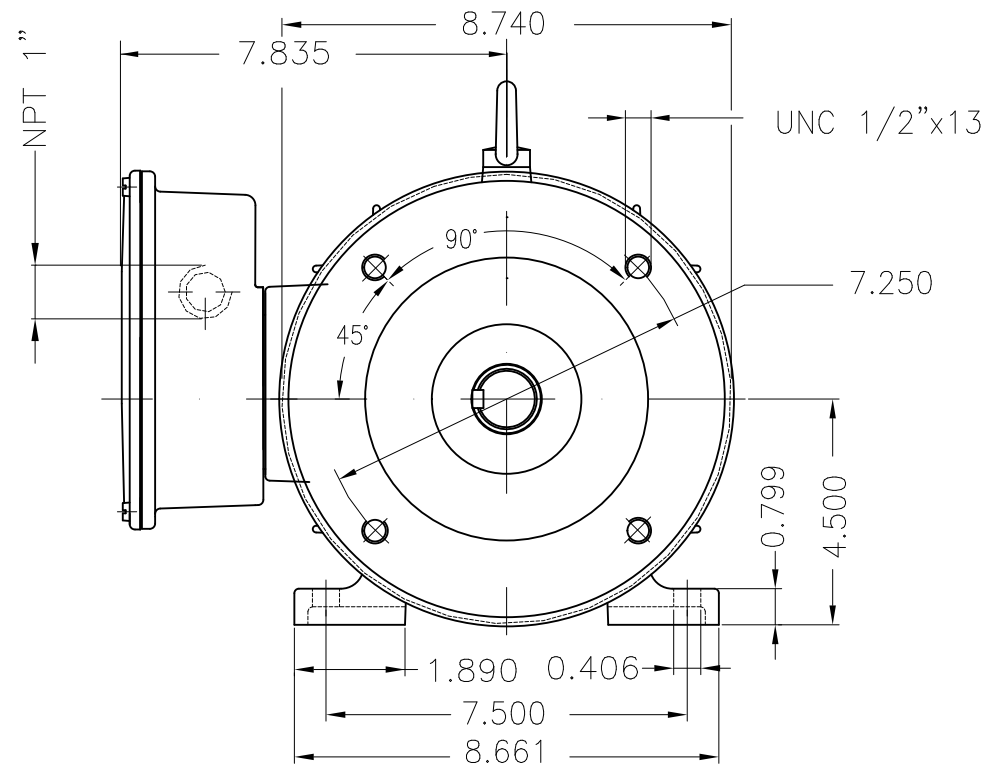

Bearing cap										
Mounting B34R(D)										
ECM	LOC	SUMMARY OF MODIFICATIONS				EXECUTED	CHECKED	RELEASED	DATE	VER
EXECUTED	USERADMIN	SINGLE PHASE MOTOR								
CHECKED		FRAME 184TC IP55 TEFC								
RELEASED		WEG code: 13068691								
REL DT	24.07.2017	WMO	Jaragua do Sul	Product Engineering	SHEET	1 / 1				

3 HP 04 Poles 60Hz

A

