

Dimensional Drawing

Catalogue	Model	HP	Pole	kW	Rating	Voltage	Hz	RPM
APH5002	AEHH8R	500	2	373	Continuous	460 V	60	3600

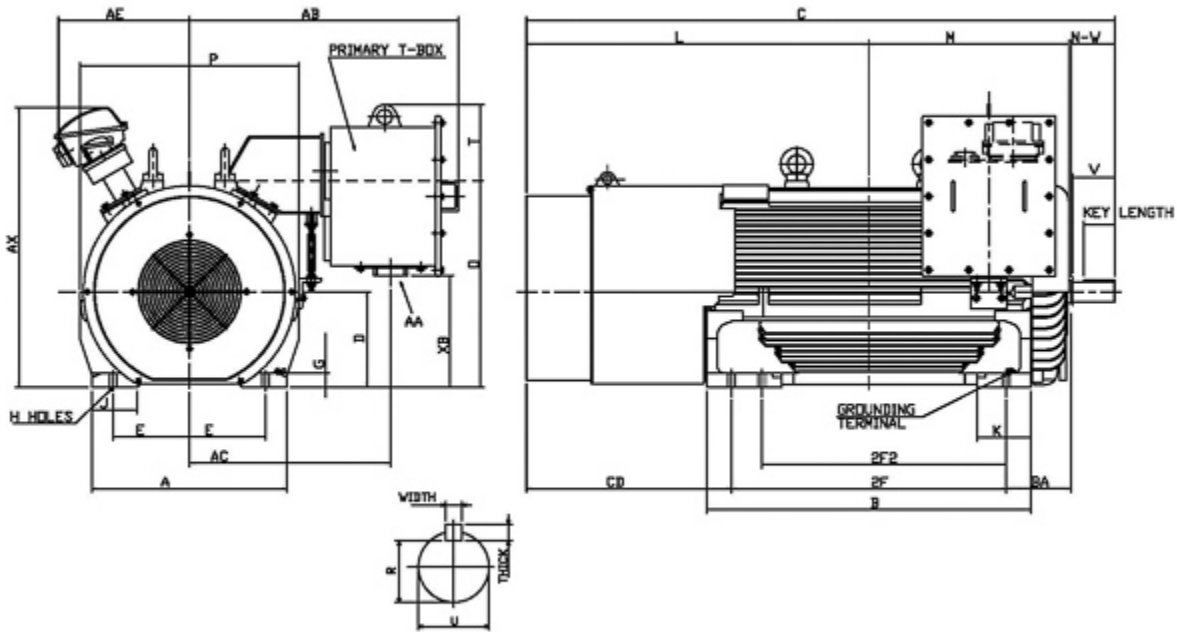

Frame Size	Mounting					A	B	C	CD	D	
	E	2F	2F2	H	BA						
5011A	10	36		0.94	8.5	25.6	42.5	77.15		12.5	
G	J	K	L	M	O	P	T	Key			Keyseat R
								Width	Thick	Length	
1.85	5.9	7.1	44.9	25.8	27.07	28.75	14.7	0.625	0.625	4.01	2.275
Terminal Housing			Aux Box			C/D Flange					
AA	AB	AC	XB	AE	AX	BB	AH	AK	BD	AJ	BF
	36.95	24.8	14.67	17.83	36.67						
Shaft Extension			Bearings		Approx. Weight Lbs	SPL dBA/3ft	Ins. Class	S.F.	Drive Method	Dimensions	
N-W	U	V	DE	NDE							
5.75	2.625	5.5	6315C3	6315C3	4600	83	F	1.15	Direct Coupling	Inches	

Technical Data Sheet

Motor Type: AEHH8R

Catalogue No: APH5002

Nameplate Information

HP	Pole	RPM	Frame	Voltage	Hz	Phase
500	2	3580	5011A	460	60	3
Enclosure	Ins. Class	Service Factor	Time Rating	NEMA Design	Rated Amb.	Rated Altitude
TEFC	F	1.15	Continuous	B	-40 to 40 °C	<3300 ft

Typical Performance

Efficiency (%)				Power Factor (%)		
Full Load		3/4 Load	1/2 Load	Full Load	3/4 Load	1/2 Load
Nom.	Min.					
95.8	95.0	95.4	94.0	91.7	91.0	87.0
Torque				Current (A)		
Full Load (lb-ft)	Locked Rotor (% FLT)	Pull Up (% FLT)	Break Down (% FLT)	No Load	Full Load	Locked Rotor
732.50	80	80	230	79.9	532.9	3625
NEMA KVA Code	Inertia (WR ²)			Safe Stall Time (s)		Noise Level Sound Press. dB(A)
	Rotor (lb-ft ²)	NEMA Load (lb-ft ²)	Max. Allowable (lb-ft ²)	Cold	Hot	
G	84.700	381	381	32	23	83

VFD Duty Information

Speed Range			VFD		S.F.
Constant Torque	Variable Torque	Constant Power	Carrier	Type	
20-60Hz	3-60Hz	60-120Hz	≤ 5 kHz	VPWM or CPWM	1.0 Only

Additional Information

Bearings		Approx. Weight
DE	NDE	lbs
6315C3	6315C3	4600

Hazardous Locations Information

CSA Certified	
Class I, Div 2, Groups B, C & D	
Class I, Zone 2, Groups IIB+H2, IIB & IIA	
Temp Code (Sinewave / VFD)	T3C / T2B