

DATE NOV. 23, 2010	OUTLINE DIMENSIONS 3-PHASE INDUCTION MOTOR	MOTOR TYPE: AEHH8P
CAT. #: NP7/52		FRAME NO. 213T

Pole	HP	kW	Hz	VOLT	Syn.Speed r/min(rpm)
2	7.5	5.6	60	230/460	3600

Ins	Rating	Dimension in	Approx Weight	Bearings	
F	CONT.	inch	150 lbs.	DE: 6308ZZ	NDE: 6306ZZ

Totally Enclosed Fan-Cooled Type. Squirrel-Cage Rotor.

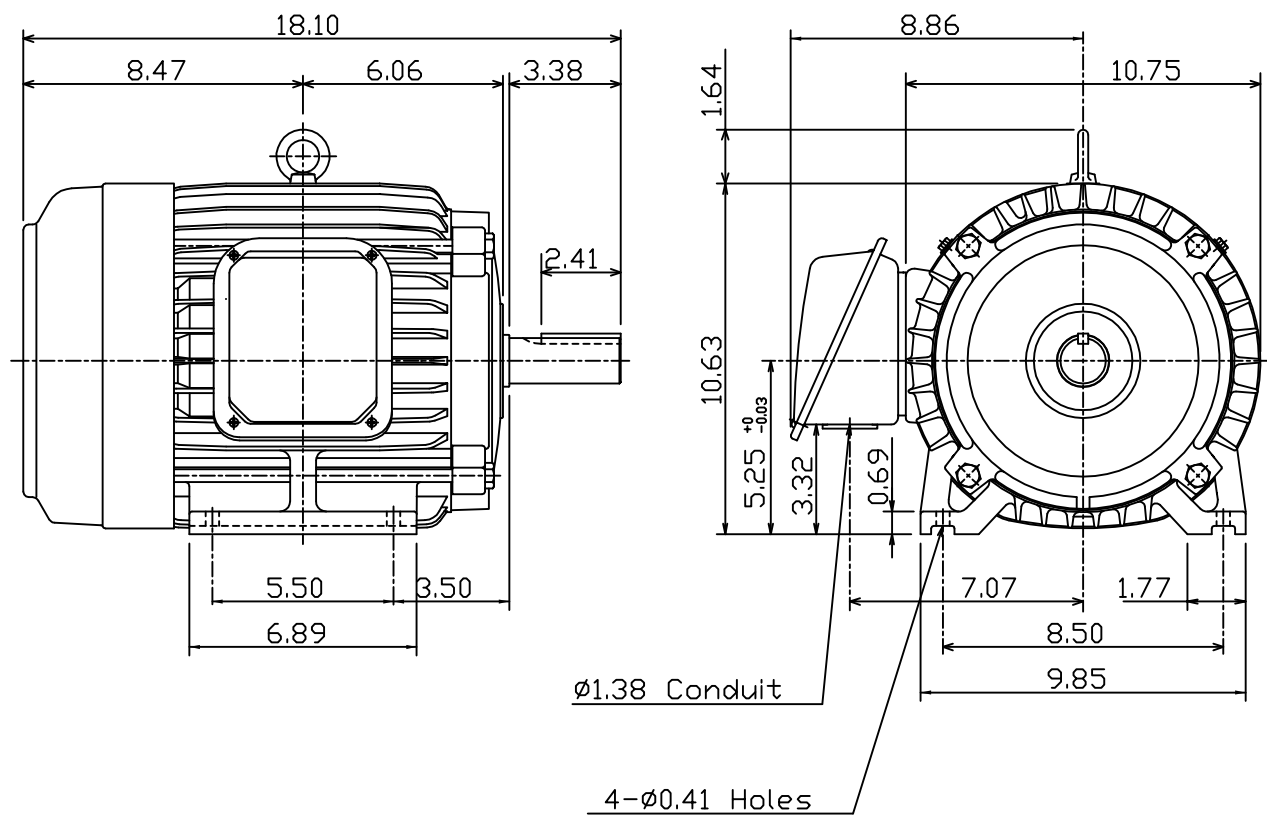

① 09.24.01	S.L.CHIAN
------------	-----------

DWN. J.H.LIANG 05-20-99	TECO  Westinghouse 	DWG NO.
CHKD. C.S.LO 05-26-99		31049D191451
APPD. Y.B.HUANG 05-26-99		