

Dimensões em polegada
Dimensions in inches

THIS IS AN UPDATED REVISION, THE
PREVIOUS ONE MUST BE DISREGARDED.

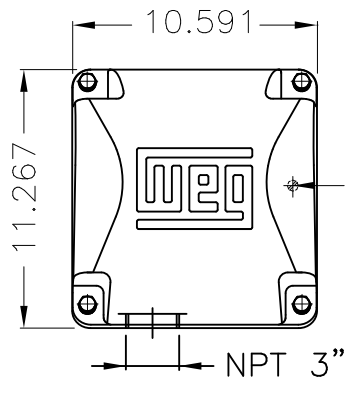

Grounding for leads 25-50 mm² / 3-1 AWG

Main terminal box

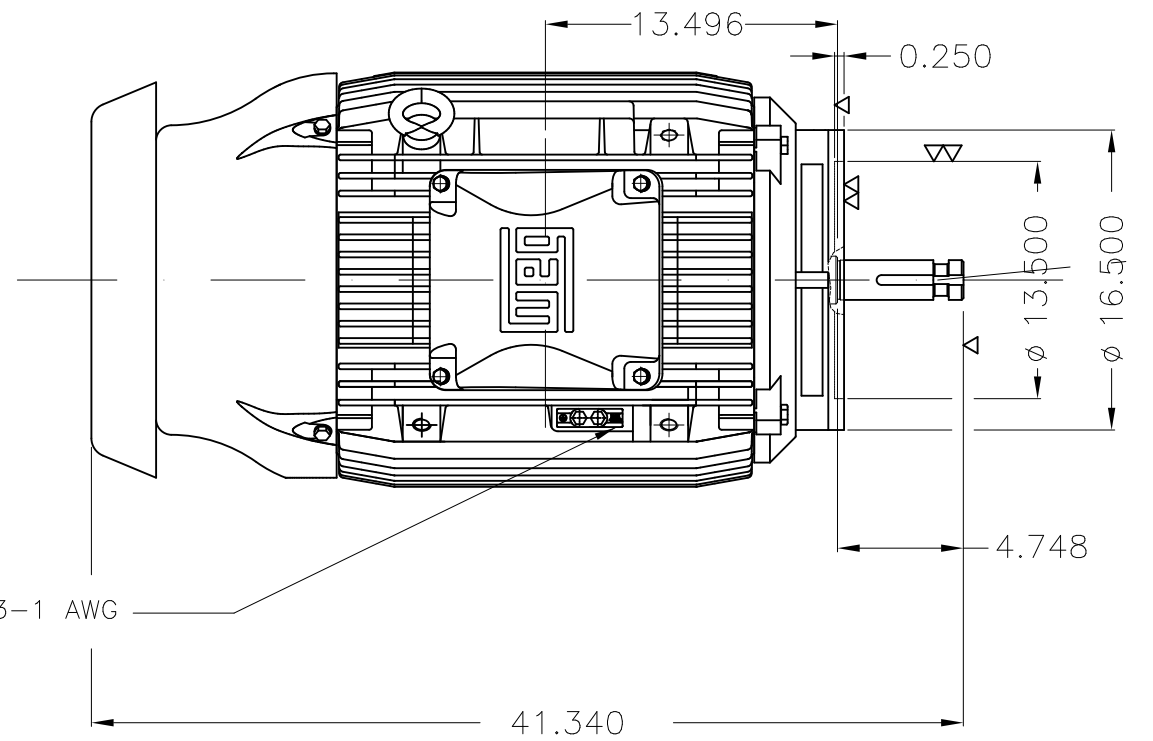
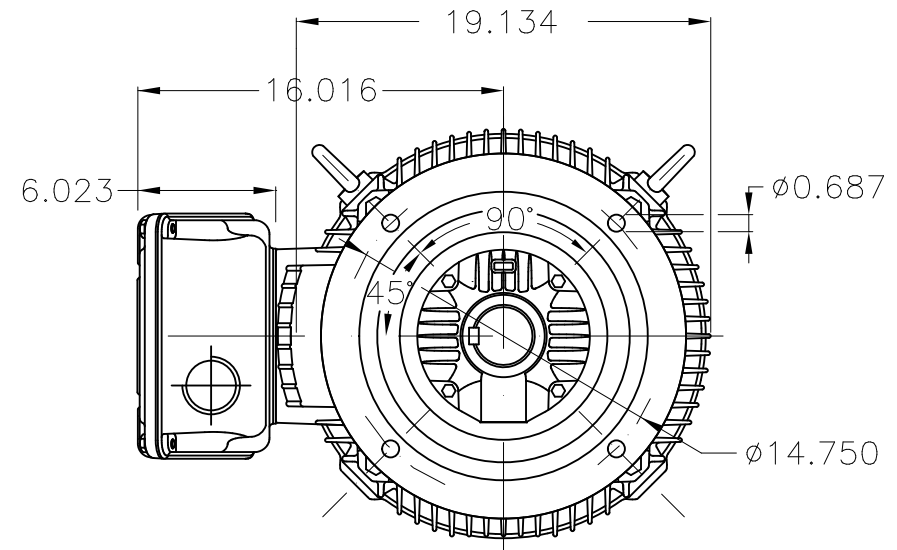

Center hole
DUNC 5/8"-11 WEG TBG12
(DIN 332)

Grounding for leads 25-50 mm² / 3-1 AWG

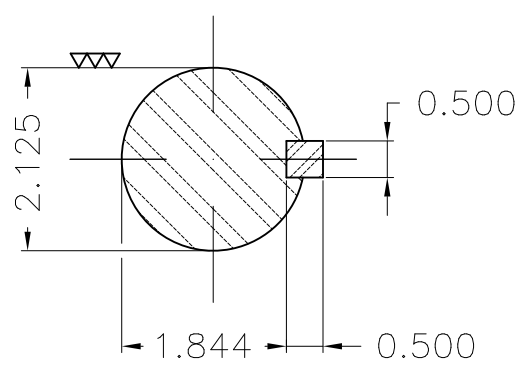
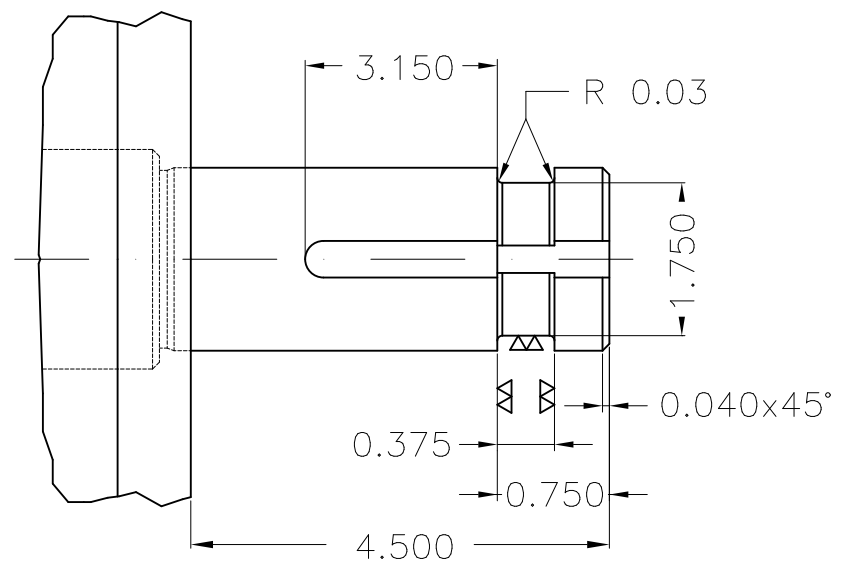

Color RAL 5009
Painting plan 203A
Mounting V1

ECM	LOC	SUMMARY OF MODIFICATIONS	EXECUTED	CHECKED	RELEASED	DATE	VER
EXECUTED	USERADMIN	THREE PHASE W22 P-BASE MOTOR PREMIUM EFF					
CHECKED		FRAME 404/5HPH IP55 TEFC					
RELEASED		WEG code: 13502112					
REL DT	24.07.2017	WMO Jaragua do Sul	Product Engineering	SHEET	1 / 1		

100 HP 02 Poles 60Hz

A



ZME A3