

Dimensões em polegada
Dimensions in inches

THIS IS AN UPDATED REVISION, THE
PREVIOUS ONE MUST BE DISREGARDED.

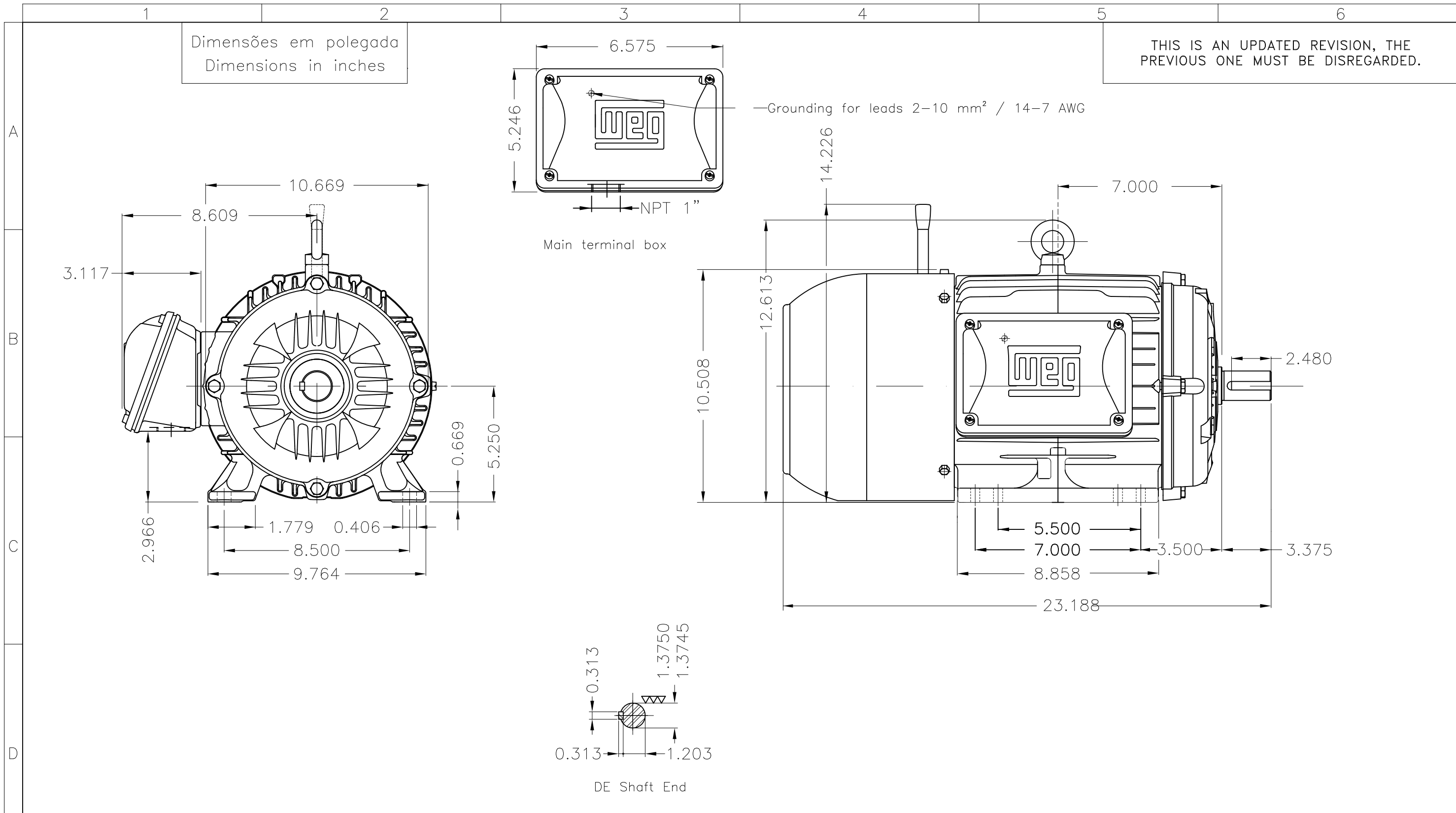

Color RAL 5009
Painting plan 207A
Mounting B3R(D)

ECM	LOC	SUMMARY OF MODIFICATIONS	EXECUTED	CHECKED	RELEASED	DATE	VER
EXECUTED	USERADMIN	W22 THREE PHASE BRAKE MOTOR - NEMA PREMIUM EFF					
CHECKED		FRAME 213/5T IP55 TEFC					
RELEASED		WEG code: 13474050					
REL DT	24.07.2017	WMO Jaraguá do Sul	Product Engineering	SHEET	1 / 1		



5 HP 06 Poles 60Hz

A