

Dimensões em polegada  
Dimensions in inches

THIS IS AN UPDATED REVISION, THE  
PREVIOUS ONE MUST BE DISREGARDED.

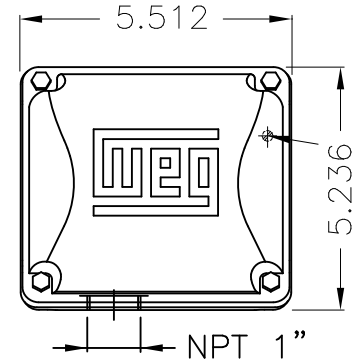
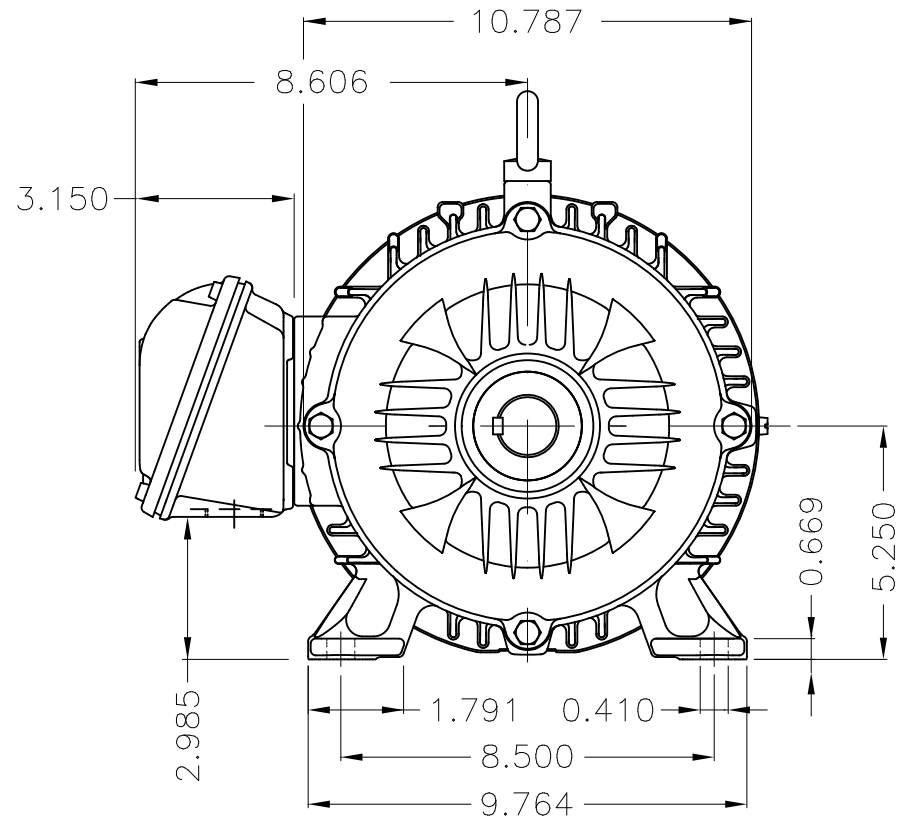

Main terminal box

Grounding for leads 2-10 mm<sup>2</sup> / 14-7 AWG

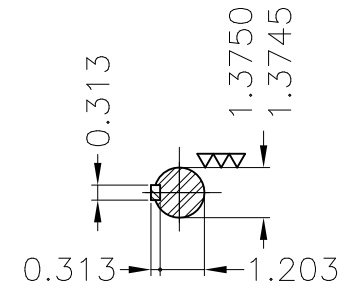
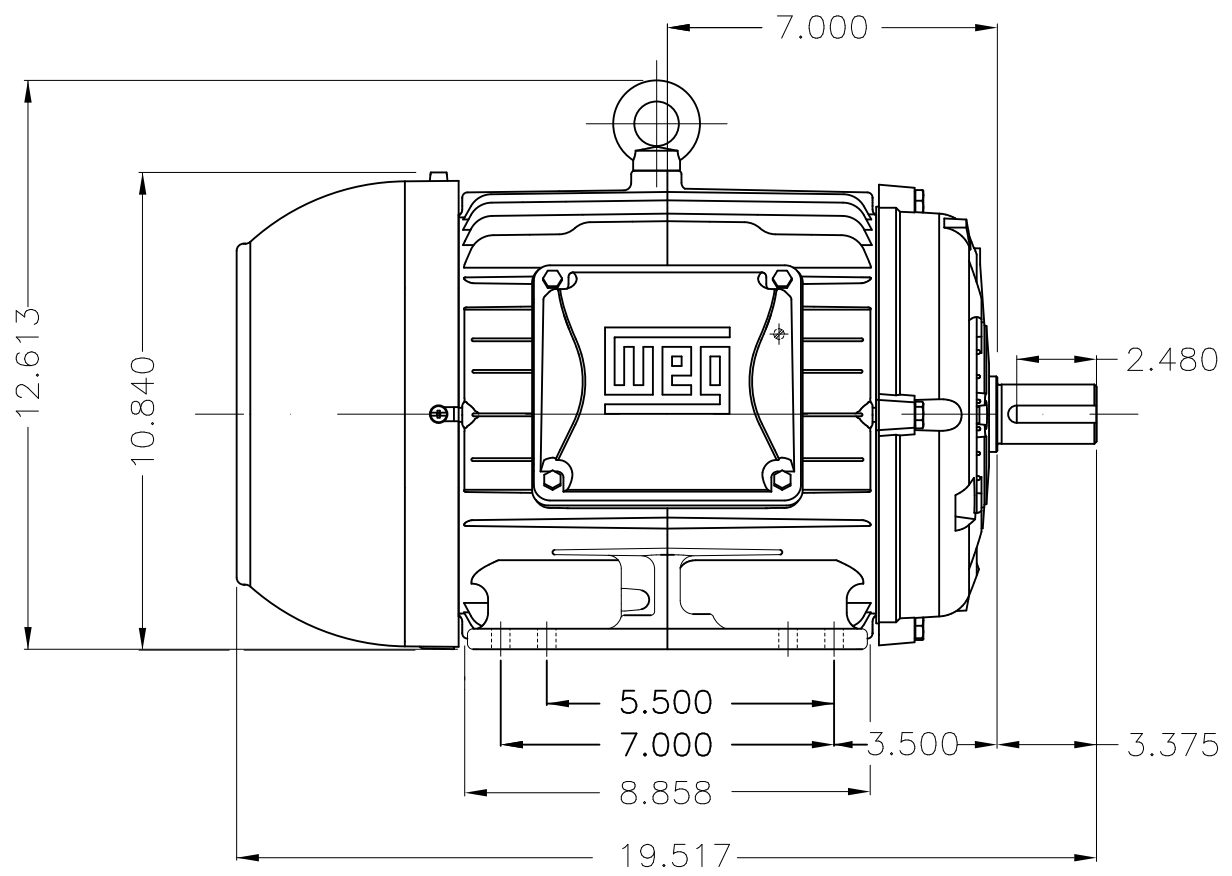

DE Shaft End

Color RAL 6002  
Painting plan 207A  
Mounting B3R(D)

ECM	LOC	SUMMARY OF MODIFICATIONS			EXECUTED	CHECKED	RELEASED	DATE	VER
EXECUTED	USERADMIN		THREE PHASE W22 MOTOR-SUPER PREMIUM EFF						
CHECKED			FRAME 213/5T IP55 TEFC						
RELEASED			WEG code: 12792176						
REL DT	24.07.2017	WMO	Jaragua do Sul	Product Engineering	SHEET	1 / 1			

3 HP 06 Poles 60Hz

A

