

Dimensional Drawing

Catalogue	Model	HP	Pole	kW	Rating	Voltage	Hz	RPM
VCN02525	AMRCNH	25	2	19	Continuous	575 V	60	3600

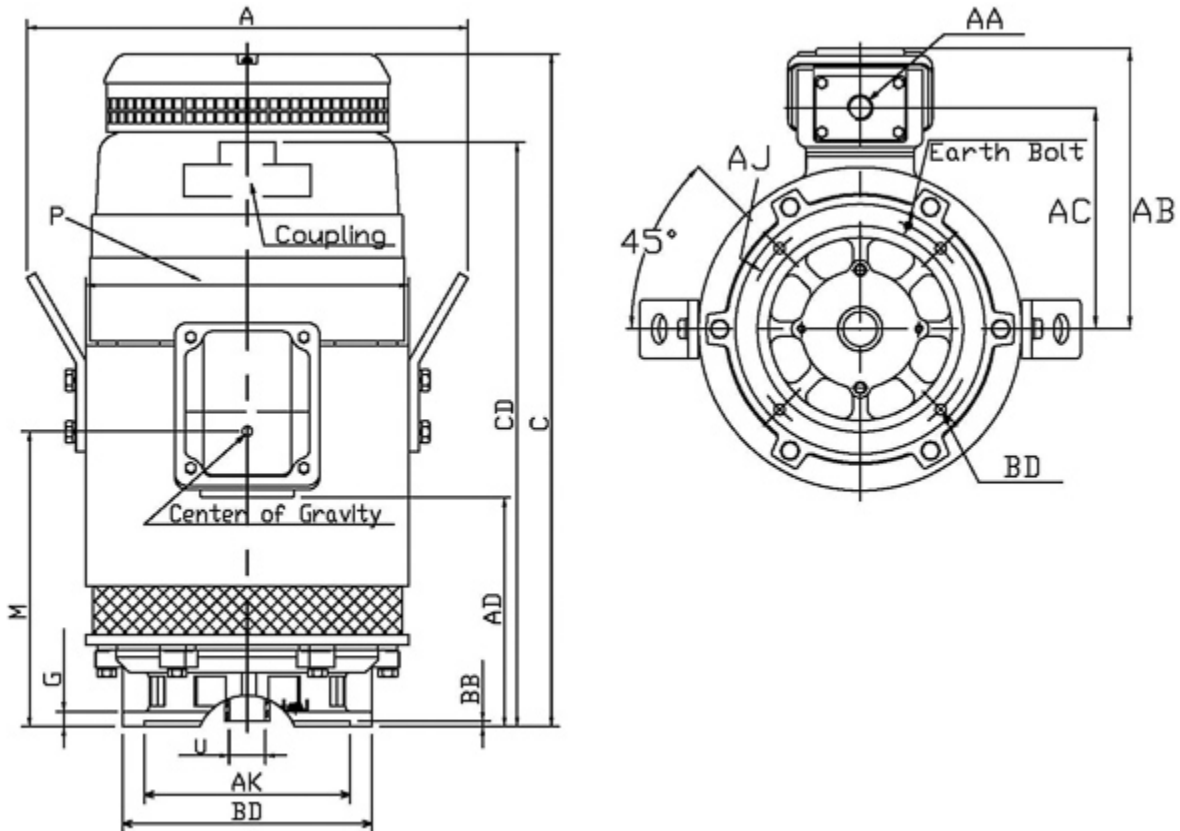

Frame Size	Mounting					A	B	C	CD	D	
	E	2F	2F2	H	BA						
256TP						17.68		26.91	23.38		
G	J	K	L	M	O	P	T	Key			Keyseat R
								Width	Thick	Length	
						12.95					
Terminal Housing			Aux Box			C/D Flange					
AA	AB	AC	XB	AE	AX	BB	AH	AK	BD	AJ	BF
1.25" NPT	11.3	8.86				0.25		8.25	10	9.125	0.44
Shaft Extension			Bearings		Approx. Weight Lbs	SPL dBA/3ft	Ins. Class	S.F.	Drive Method	Dimensions	
N-W	U	V	DE	NDE							
	1.378		6309ZZC3	7311B	324	0	F	1.15	Direct Coupling	Inches	

Technical Data Sheet

Motor Type: AMRCNH

Catalogue No: VCN02525

Nameplate Information

HP	Pole	RPM	Frame	Voltage	Hz	Phase
25	2	3530	256TP	575	60	3
Enclosure	Ins. Class	Service Factor	Time Rating	NEMA Design	Rated Amb.	Rated Altitude
WPI	F	1.15	Continuous	B	-40 to 40 °C	<3300 ft

Typical Performance

Efficiency (%)				Power Factor (%)		
Full Load		3/4 Load	1/2 Load	Full Load	3/4 Load	1/2 Load
Nom.	Min.					
91.7	90.2	92.0	92.0	91.0	90.0	85.0
Torque				Current (A)		
Full Load (lb-ft)	Locked Rotor (% FLT)	Pull Up (% FLT)	Break Down (% FLT)	No Load	Full Load	Locked Rotor
37.18	210	155	250	4.3	22.4	146
NEMA KVA Code	Inertia (WR ²)			Safe Stall Time (s)		Noise Level Sound Press. dB(A)
	Rotor (lb-ft ²)	NEMA Load (lb-ft ²)	Max. Allowable (lb-ft ²)	Cold	Hot	
G	1.213	26	38	17	12	0

VFD Duty Information

Speed Range			VFD		S.F.
Constant Torque	Variable Torque	Constant Power	Carrier	Type	
0	7.5-60Hz:	0	≤ 3 kHz	VPWM or CPWM	1.0 Only

Additional Information

Bearings		Approx. Weight
DE	NDE	lbs
6309ZZC3	7311B	324

Hazardous Locations Information

0	
0	
0	
Temp Code (Sinewave / VFD)	0 / 0