

Dimensões em polegada  
Dimensions in inches

THIS IS AN UPDATED REVISION, THE  
PREVIOUS ONE MUST BE DISREGARDED.

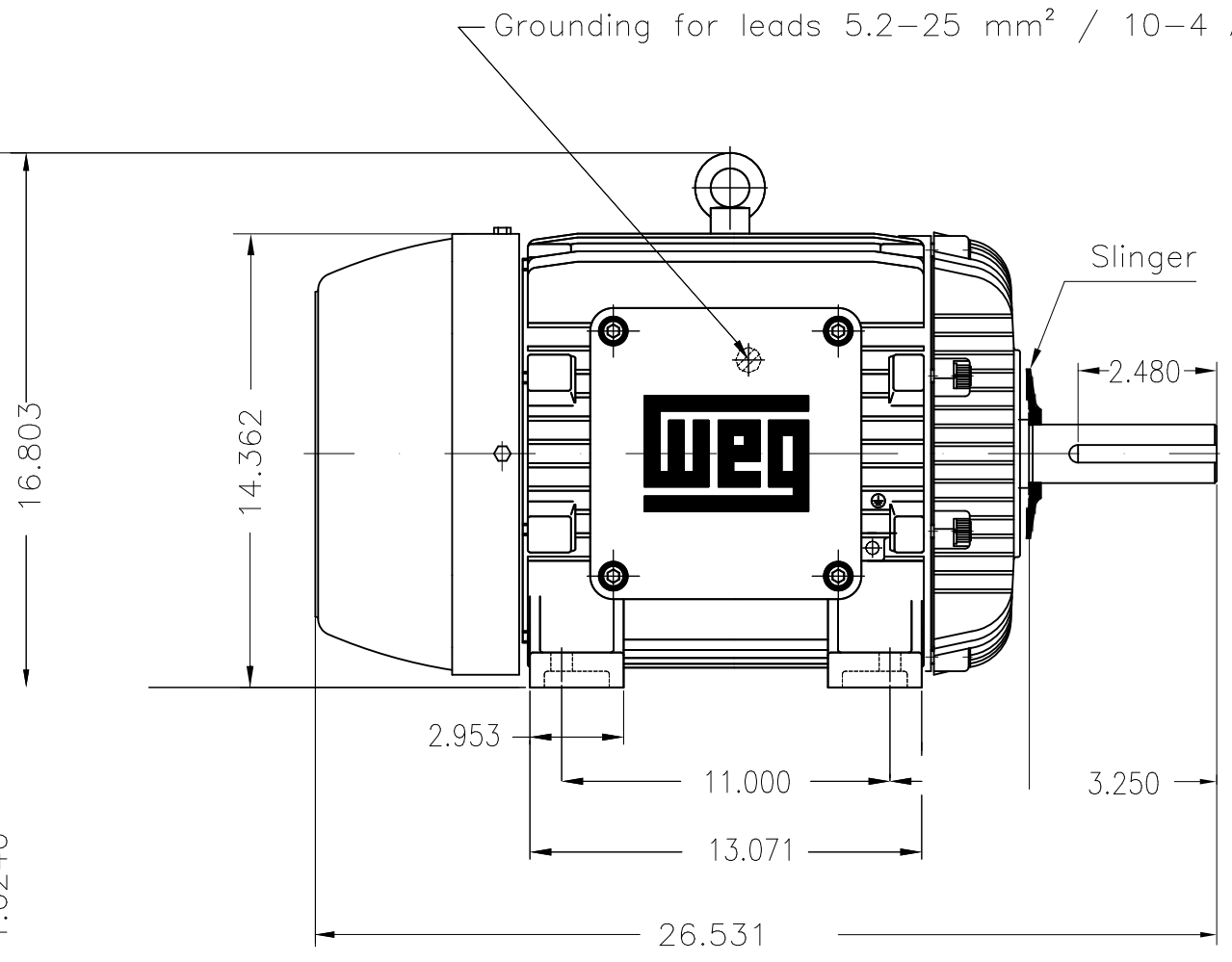
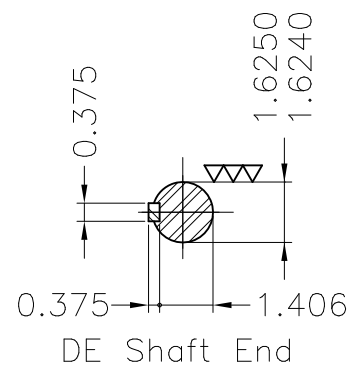
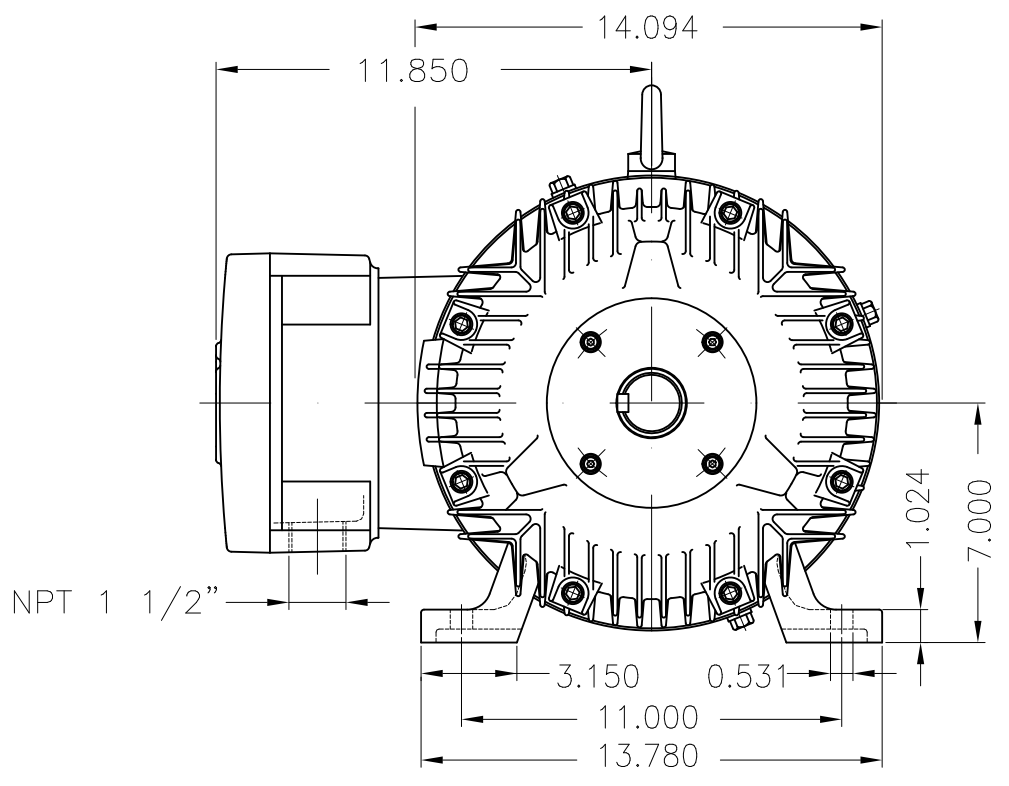

Grease - WT/ENS  
Color RAL 5009  
Painting plan 202P  
Mounting B3R(D)

ECM	LOC	SUMMARY OF MODIFICATIONS	EXECUTED	CHECKED	RELEASED	DATE	VER
EXECUTED	USERADMIN	THREE PHASE EXPL. PROOF MOTOR NEMA P.EFF					
CHECKED		FRAME 286TS IP55 TEFC					
RELEASED		WEG code: 11342170					
REL DT	24.07.2017	WMO Jaragua do Sul	Product Engineering	SHEET	1 / 1		

30 HP 02 Poles 60Hz

A

