

Dimensional Drawing

Catalogue	Model	HP	Pole	kW	Rating	Voltage	Hz	RPM
XH0052	AEHHXV	5	2	3.7	Continuous	230 / 460 V	60	3600

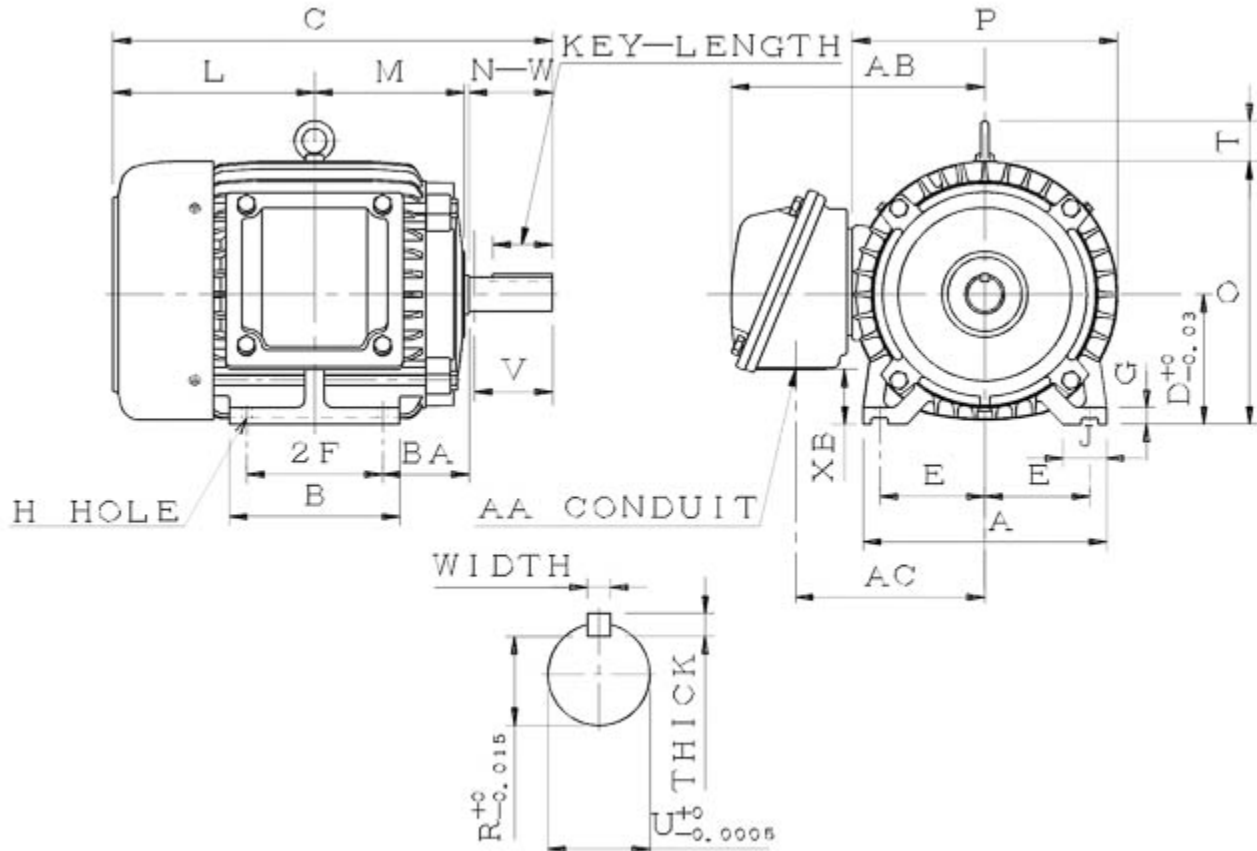

AEHHXV-SMP-2 1 0

Frame Size	Mounting					A	B	C	CD	D	
	E	2F	2F2	H	BA						
184T	3.75	5.5		0.41	2.75	8.8	6.9	15.91		4.5	
G	J	K	L	M	O	P	T	Key			Keyseat
0.65	1.75		7.66	5.41	9.35	9.6	1.15	Width	Thick	Length	R
								0.25	0.25	1.78	0.986
Terminal Housing				Aux Box		C/D Flange					
AA	AB	AC	XB	AE	AX	BB	AH	AK	BD	AJ	BF
NPT3/4"	8.78	6.45	2.33								
Shaft Extension			Bearings		Approx. Weight Lbs	SPL dBA/3ft	Ins. Class	S.F.	Drive Method	Dimensions	
N-W	U	V	DE	NDE							
2.75	1.125	2.7	6306ZZ	6306ZZ	120	68	F	1.15	Direct Coupling / Belt Drive	Inches	

Technical Data Sheet

Motor Type: AEHHXV

Catalogue No: XH0052

Nameplate Information

HP	Pole	RPM	Frame	Voltage	Hz	Phase
5	2	3490	184T	230 / 460	60	3
Enclosure	Ins. Class	Service Factor	Time Rating	NEMA Design	Rated Amb.	Rated Altitude
TEXP	F	1.15	Continuous	B	-40 to 40 °C	<3300 ft

Typical Performance

Efficiency (%)				Power Factor (%)		
Full Load		3/4 Load	1/2 Load	Full Load	3/4 Load	1/2 Load
Nom.	Min.					
88.5	86.5	90.0	90.0	91.0	89.5	83.5
Torque				Current (A)		
Full Load (lb-ft)	Locked Rotor (% FLT)	Pull Up (% FLT)	Break Down (% FLT)	No Load	Full Load	Locked Rotor
8	260	210	305	3.0 / 1.5	11.6 / 5.8	92 / 46
NEMA KVA Code	Inertia (WR ²)			Safe Stall Time (s)		Noise Level Sound Press. dB(A)
	Rotor (lb-ft ²)	NEMA Load (lb-ft ²)	Max. Allowable (lb-ft ²)	Cold	Hot	
J	0.249	6	13	17	12	68

VFD Duty Information

Speed Range			VFD		S.F.
Constant Torque	Variable Torque	Constant Power	Carrier	Type	
12-60Hz	3-60Hz	60-90Hz	≤ 5 kHz	VPWM or CPWM	1.0 Only

Additional Information

Bearings		Approx. Weight
DE	NDE	lbs
6306ZZ	6306ZZ	120

Hazardous Locations Information

CSA/UL Certified	
Class I, Div 1, Groups C & D; Class II, Div 1, Groups E, F & G Class I, Zone 1, Groups IIB & IIA; Class II, Div 1, Groups E, F & G	
Temp Code (Sinewave / VFD)	T3B / T3B