

DATE
Sept. 12, 2005
CAT. #: HH0204

OUTLINE DIMENSIONS
3-PHASE INDUCTION MOTOR

MOTOR TYPE:
AEHH
FRAME NO. 256T

Pole	HP	kW	Hz	VOLT	Syn. Speed r/min(rpm)
4	20	15	60	460	1800

Ins	Rating	Dimension in	Approx Weight	Bearings
F	CONT.	inches	337 lbs.	DE: 6309ZC35CNDE: 6307ZC35C

Totally Enclosed Fan-Cooled Type. Squirrel-cage Rotor.

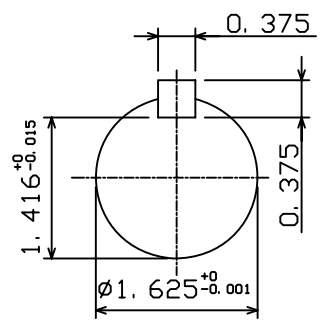
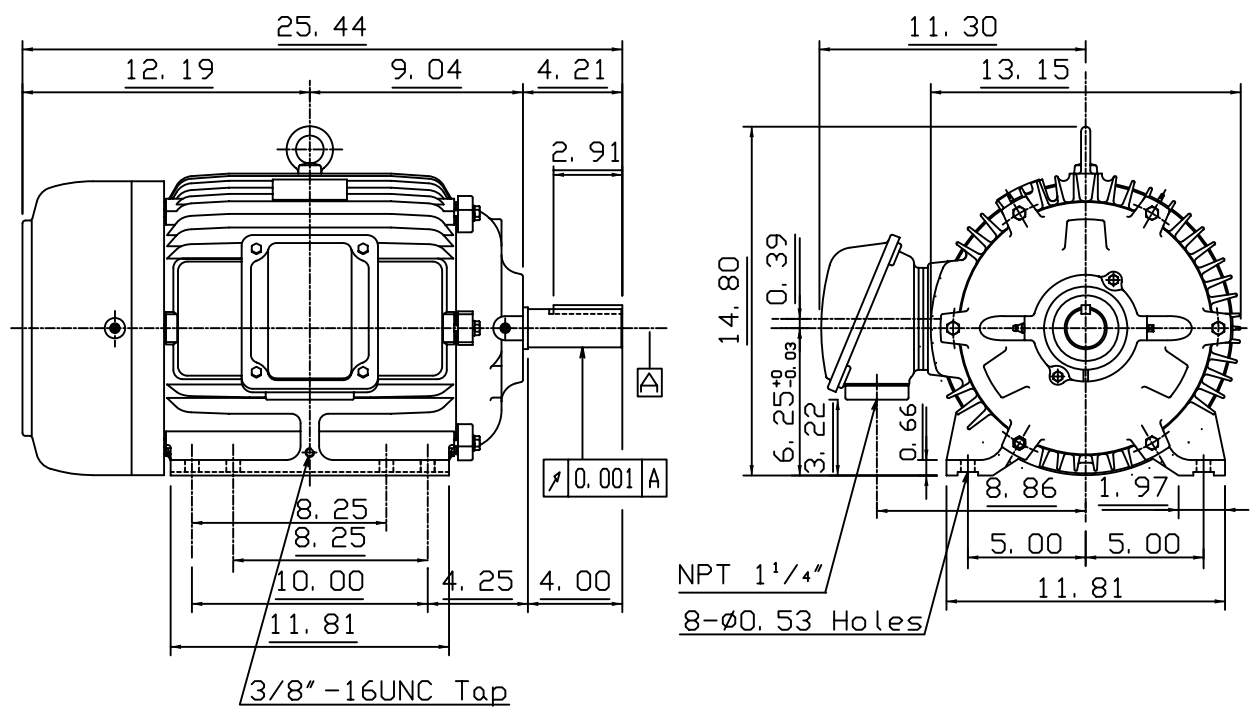

◇		
---	--	--

DWN.	K. L. KUO	01-12-05
CHKD.	C. H. KAO	02-02-05
APPD.	M. C. TSAI	02-02-05



DWG NO.
31049M626380