

Dimensões em polegada
Dimensions in inches

THIS IS AN UPDATED REVISION, THE
PREVIOUS ONE MUST BE DISREGARDED.

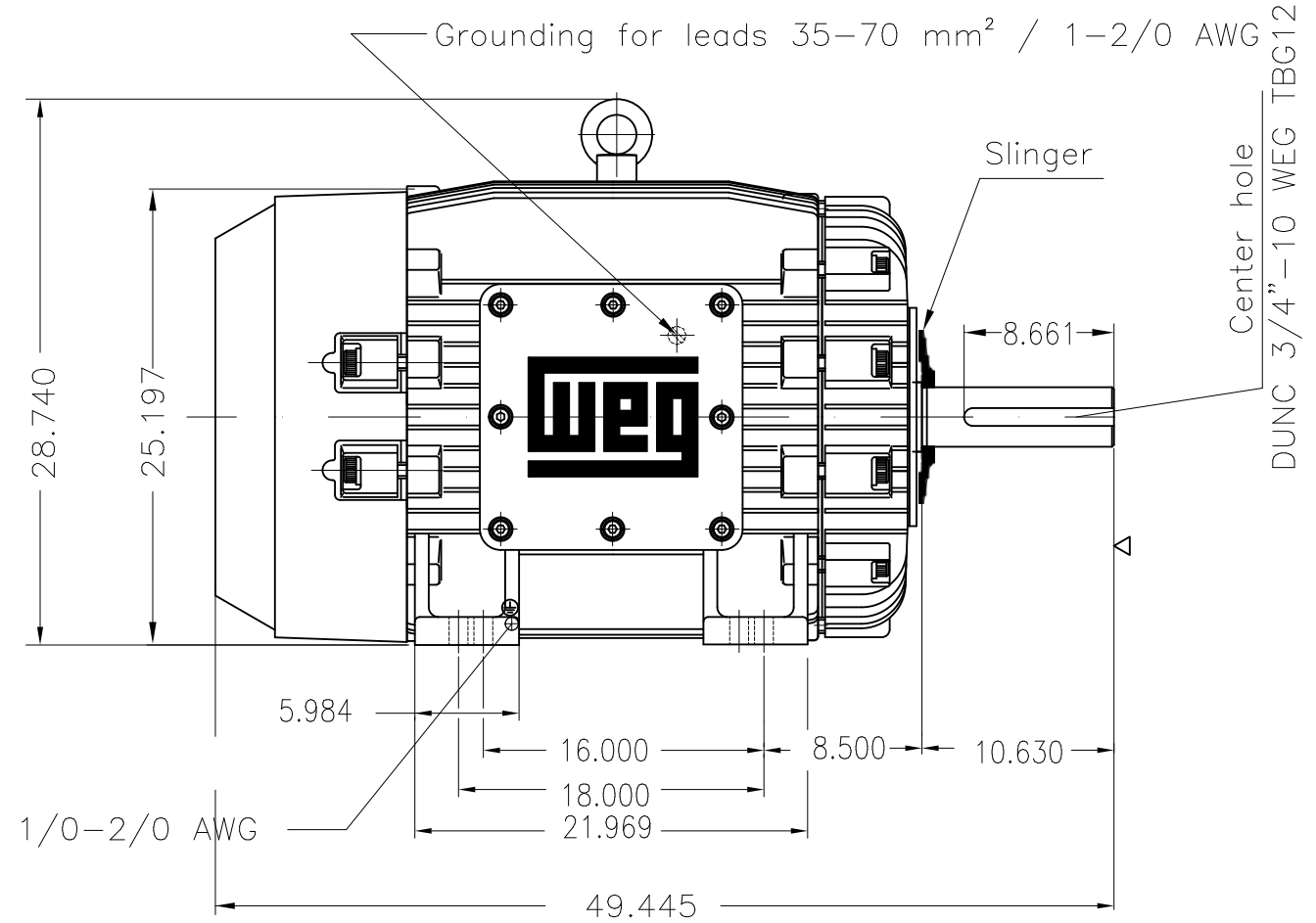

Grounding for leads 50-70 mm² / 1/0-2/0 AWG

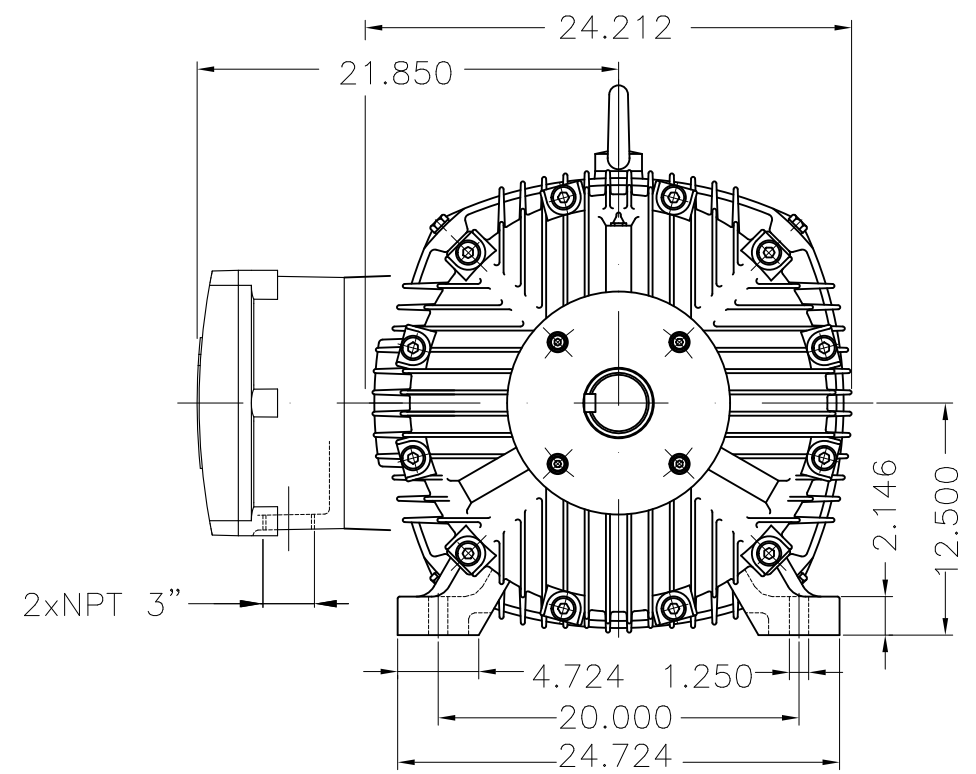
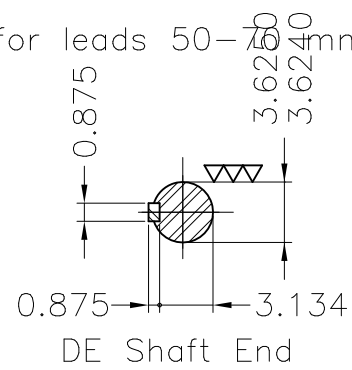

Color RAL 5009
Painting plan 202P
Mounting B3R(D)

| ECM | LOC | SUMMARY OF MODIFICATIONS | EXECUTED | CHECKED | RELEASED | DATE | VER |
|----------|------------|--|---------------------|---------|----------|------|-----|
| EXECUTED | USERADMIN | THREE PHASE EXPL. PROOF MOTOR NEMA P.EFF | | | | | |
| CHECKED | | FRAME 504/5T IP55 TEFC | | | | | |
| RELEASED | | WEG code: 12408378 | | | | | |
| REL DT | 24.07.2017 | WMO Jaragua do Sul | Product Engineering | SHEET | 1 / 1 | | |

150 HP 06 Poles 60Hz

A

