

Dimensões em polegada
Dimensions in inches

THIS IS AN UPDATED REVISION, THE
PREVIOUS ONE MUST BE DISREGARDED.

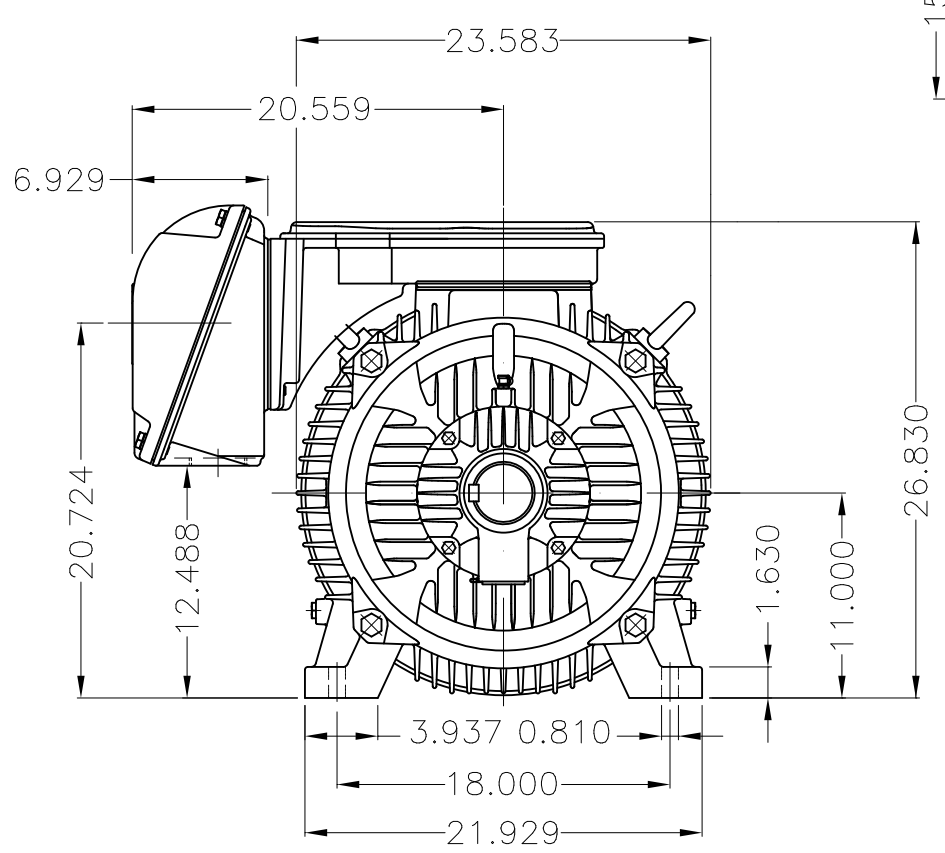

Main terminal box

Grounding for leads 35-70 mm² / 1-2/0 AWG

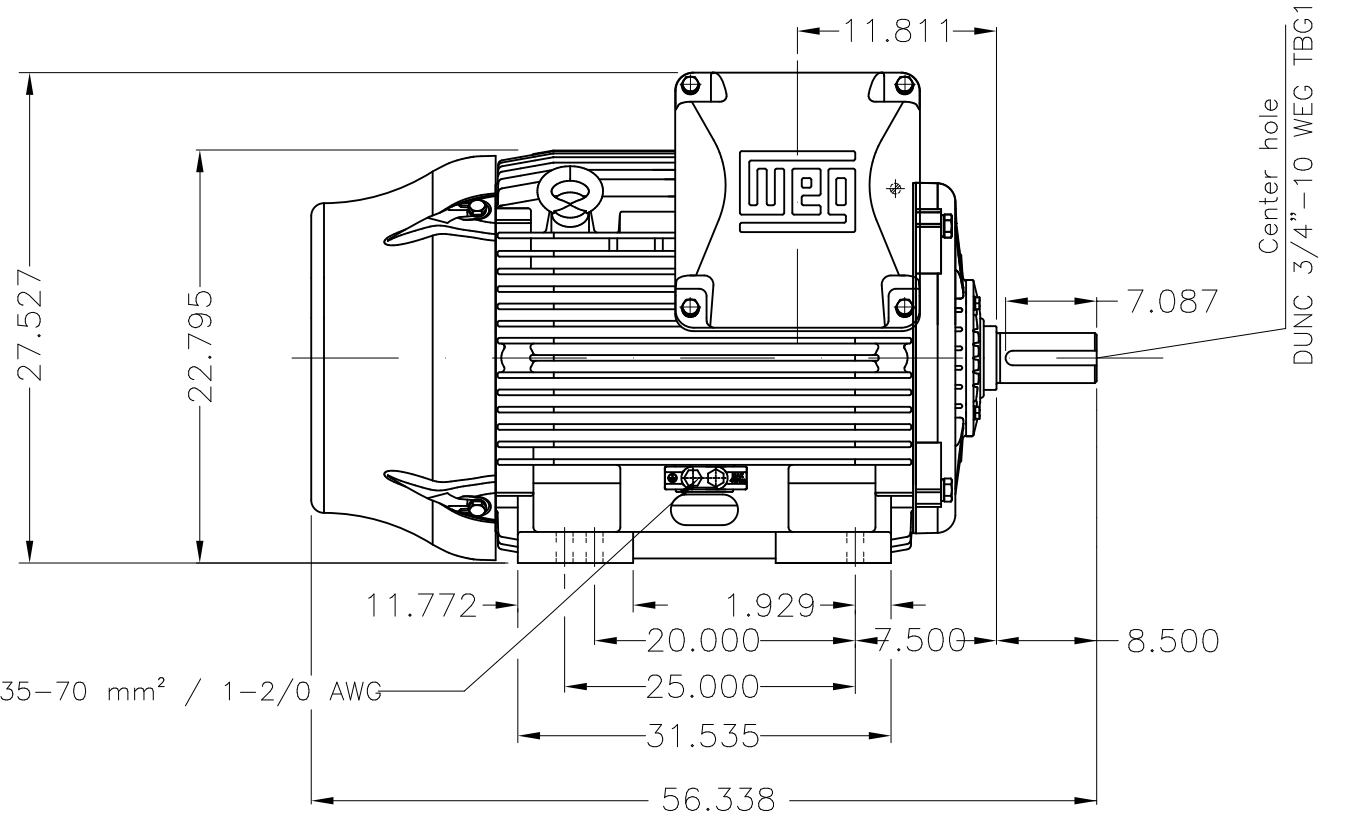

Grounding for leads 35-70 mm² / 1-2/0 AWG

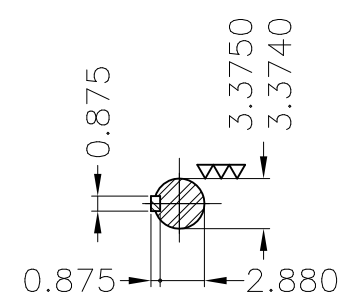

DE Shaft End

Color RAL 5009
Painting plan 202E
Mounting B3R(D)

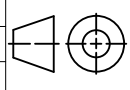
ECM	LOC	SUMMARY OF MODIFICATIONS			EXECUTED	CHECKED	RELEASED	DATE	VER
EXECUTED	USERADMIN	 THREE PH. W22 NEMA P.EFF MOTOR IEEEE841 FRAME 447/9T IP55 TEFC WEG code: 11434693							
CHECKED									
RELEASED									
REL DT	24.07.2017	WMO	Jaragua do Sul	Product Engineering	SHEET	1 / 1			

200 HP 06 Poles 60Hz

A

