

Dimensional Drawing

Catalogue	Model	HP	Pole	kW	Rating	Voltage	Hz	RPM
CJP01565	AEHH8N JP	15	6	11	Continuous	575 V	60	1200

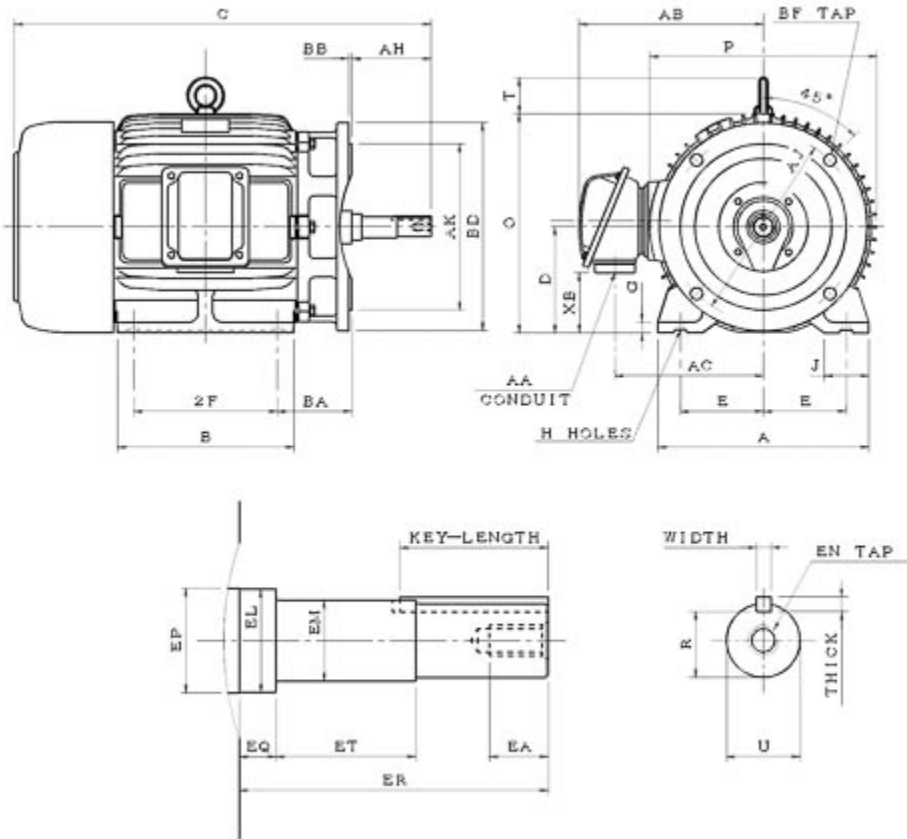

AEHH8N-JP-SMP-5

Frame Size	Mounting					A	B	C	CD	D	
	E	2F	2F2	H	BA						
284JP	5.5	9.5		0.53	4.95	13.98	13.19	30.505		7	
G	J	K	L	M	O	P	T	Key			Keyseat
0.7	2.95				14.5	15.04	2.36	Width	Thick	Length	R
								0.25	0.25	2.52	1.112
Terminal Housing			Aux Box			C/D Flange					
AA	AB	AC	XB	AE	AX	BB	AH	AK	BD	AJ	BF
1 1/2"	12.28	9.84	3.97			0.2	8.125	12.5	13.78	11	4-5/8"-11UNC
Shaft Extension			Bearings		Approx. Weight Lbs	SPL dBA/3ft	Ins. Class	S.F.	Drive Method	Dimensions	
N-W	U	V	DE	NDE							
	1.25		6311ZZ	6310ZZ	449	64	F	1.15	DirectCoupling	Inches	

Technical Data Sheet

Motor Type: AEHH8N_JP

Catalogue No: CJP01565

Nameplate Information

HP	Pole	RPM	Frame	Voltage	Hz	Phase
15	6	1175	284JP	575	60	3
Enclosure	Ins. Class	Service Factor	Time Rating	NEMA Design	Rated Amb.	Rated Altitude
TEFC	F	1.15	Continuous	B	-40 to 40 °C	<3300 ft

Typical Performance

Efficiency (%)				Power Factor (%)		
Full Load		3/4 Load	1/2 Load	Full Load	3/4 Load	1/2 Load
Nom.	Min.					
92.4	91.0	93.0	93.0	83.5	79.5	70.5
Torque				Current (A)		
Full Load (lb-ft)	Locked Rotor (% FLT)	Pull Up (% FLT)	Break Down (% FLT)	No Load	Full Load	Locked Rotor
67.03	215	180	230	5.3	14.6	93
NEMA KVA Code	Inertia (WR ²)			Safe Stall Time (s)		Noise Level Sound Press. dB(A)
	Rotor (lb-ft ²)	NEMA Load (lb-ft ²)	Max. Allowable (lb-ft ²)	Cold	Hot	
G	6.823	200	497	29	20	64

VFD Duty Information

Speed Range			VFD		S.F.
Constant Torque	Variable Torque	Constant Power	Carrier	Type	
6-60Hz	3-60Hz	60-120Hz	≤ 5 kHz	VPWM or CPWM	1.0 Only

Additional Information

Bearings		Approx. Weight
DE	NDE	lbs
6311ZZ	6310ZZ	449

Hazardous Locations Information

CSA Certified	
Class I, Div 2, Groups B, C & D	
Class I, Zone 2, Groups IIB+H2, IIB & IIA	
Temp Code (Sinewave / VFD)	T3C / T3B