

DATE
March 5, 2007
Cat. #: XV0256C

OUTLINE DIMENSIONS

3-PHASE INDUCTION MOTOR

MOTOR TYPE:
AEUHXF
FRAME NO. 324TC

Pole	HP	kW	Hz	VOLT	Syn. Speed r/min(rpm)
6	25	18.7	60	230/460	1200

Ins	Rating	Dimension in	Approx Weight	Bearings	
F	CONT.	inch	708 lbs	DE: 6312	NDE: 6212

Totally Enclosed Fan Cooled Type. Squirrel-cage Rotor.

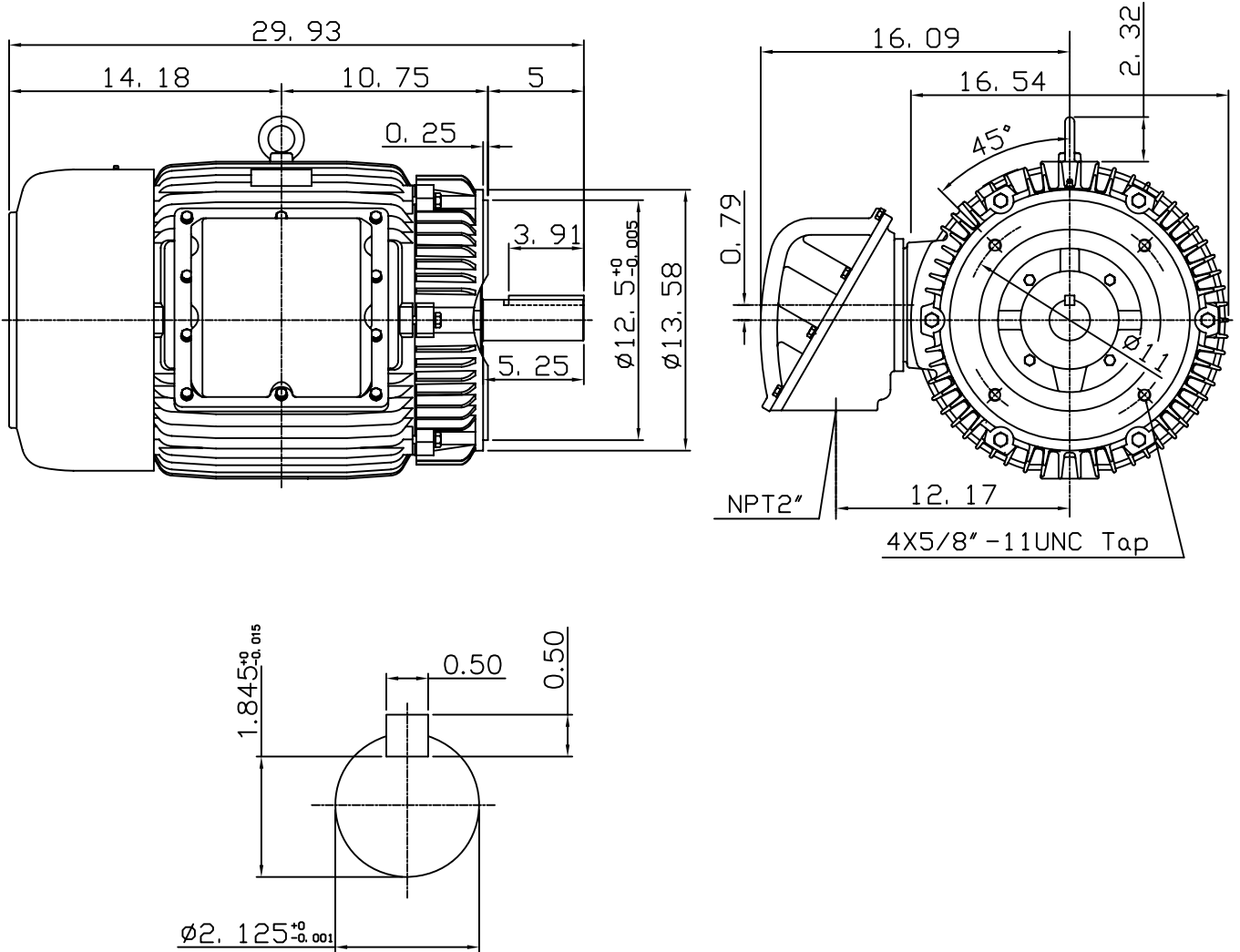

Note:
1. Suitable for division I,
class I Group D & class II
Group E, F, G, T2D or T3B.

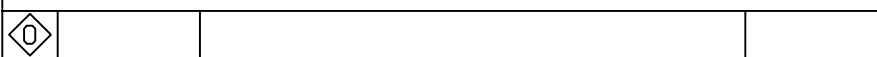

DWN.	G. L. GUO	01-02-02
CHKD.	C. H. KAO	01-03-02
APPD.	Y. B. HUANG	01-03-02



DWG NO.
31049U562000