

Dimensões em polegada
Dimensions in inches

THIS IS AN UPDATED REVISION, THE
PREVIOUS ONE MUST BE DISREGARDED.

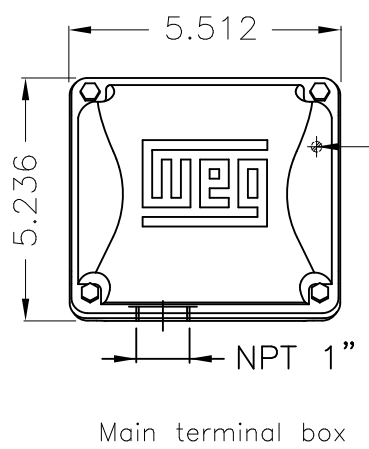

Grounding for leads 2-10 mm² / 14-7 AWG

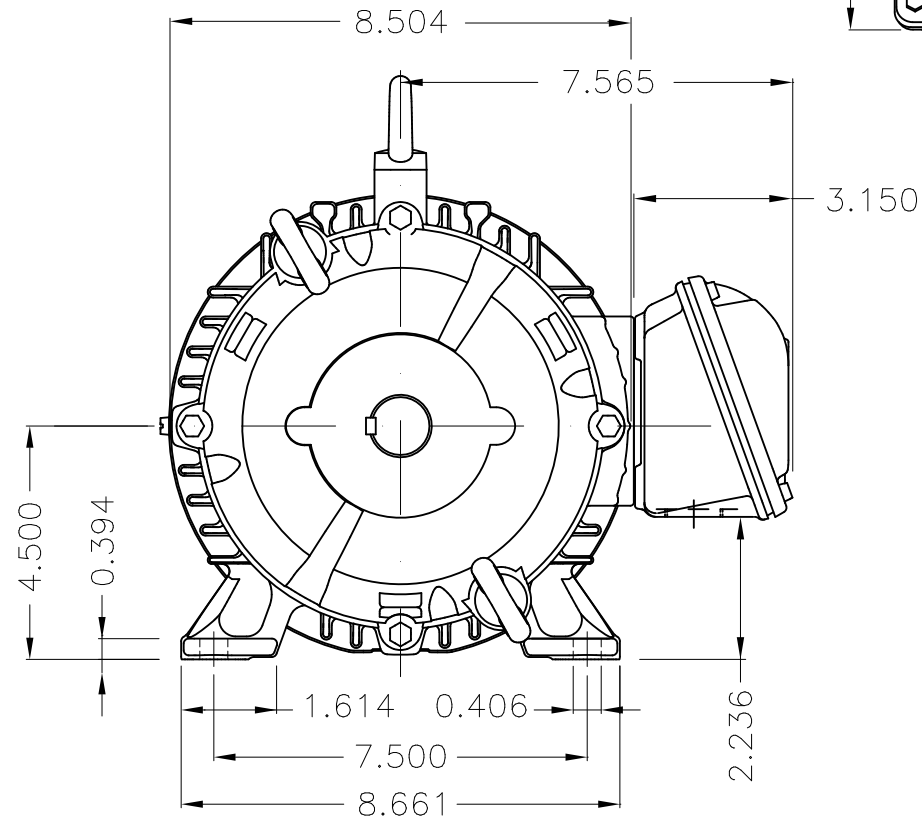
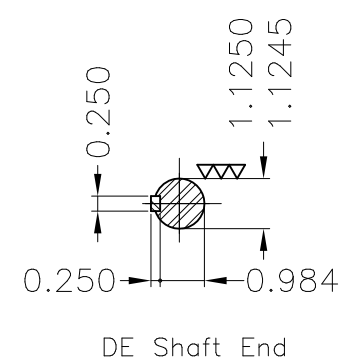
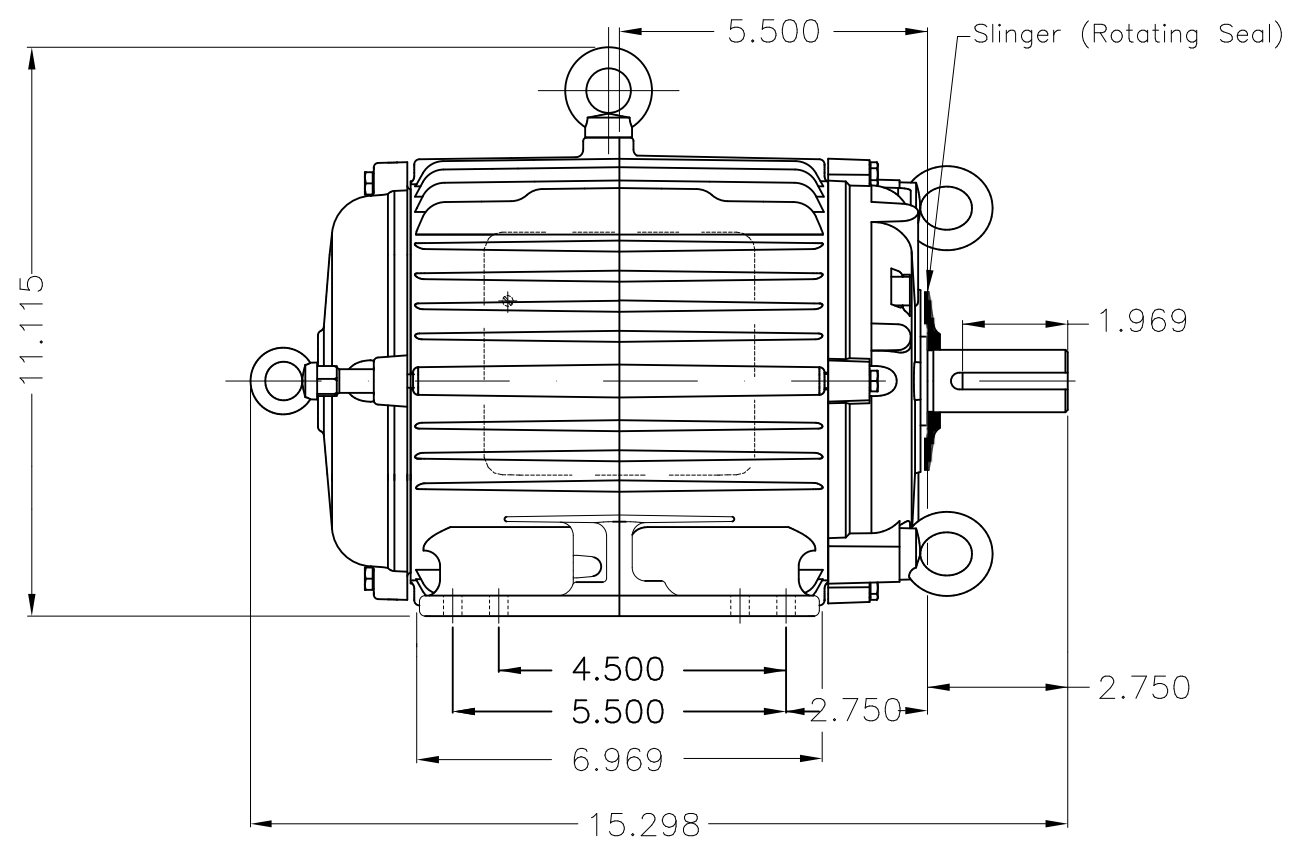

Without fan
Without fan cover
Color RAL 5009
Painting plan 202E
Mounting B3L(E)

ECM	LOC	SUMMARY OF MODIFICATIONS	EXECUTED	CHECKED	RELEASED	DATE	VER
EXECUTED	USERADMIN	THREE PH W22 MOTOR COOLING TOWER NEMA EF					
CHECKED		FRAME 182/4T IP55 TEAO					
RELEASED		WEG code: 12127659					
REL DT	24.07.2017	WMO Jaragua do Sul	Product Engineering	SHEET	1 / 1		

5 HP 04 Poles 60Hz

