

Dimensões em polegada
Dimensions in inches

THIS IS AN UPDATED REVISION, THE
PREVIOUS ONE MUST BE DISREGARDED.

Grounding for leads 5.2–35 mm² / 10–2 AWG

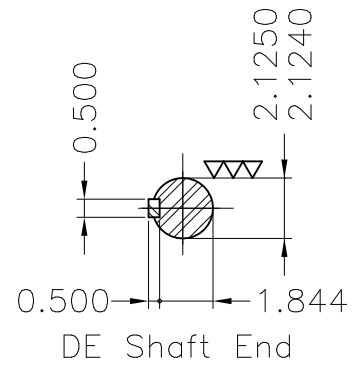
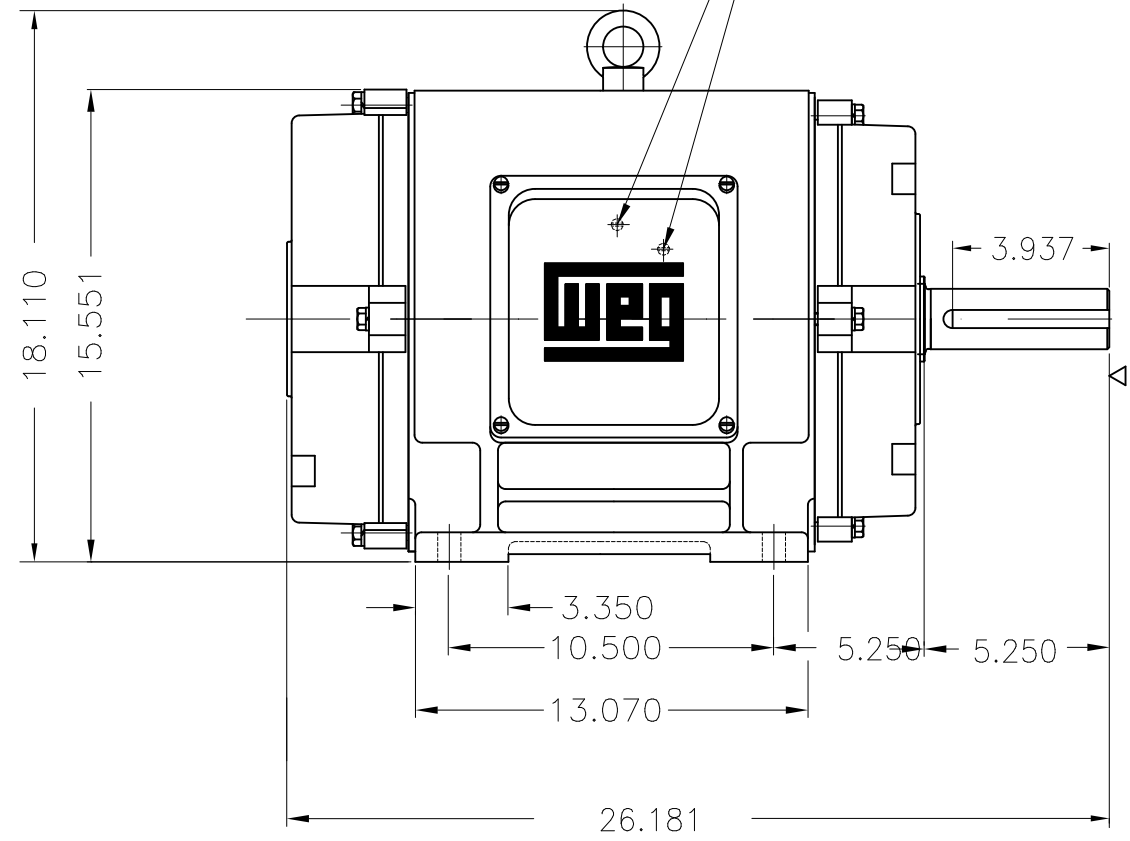
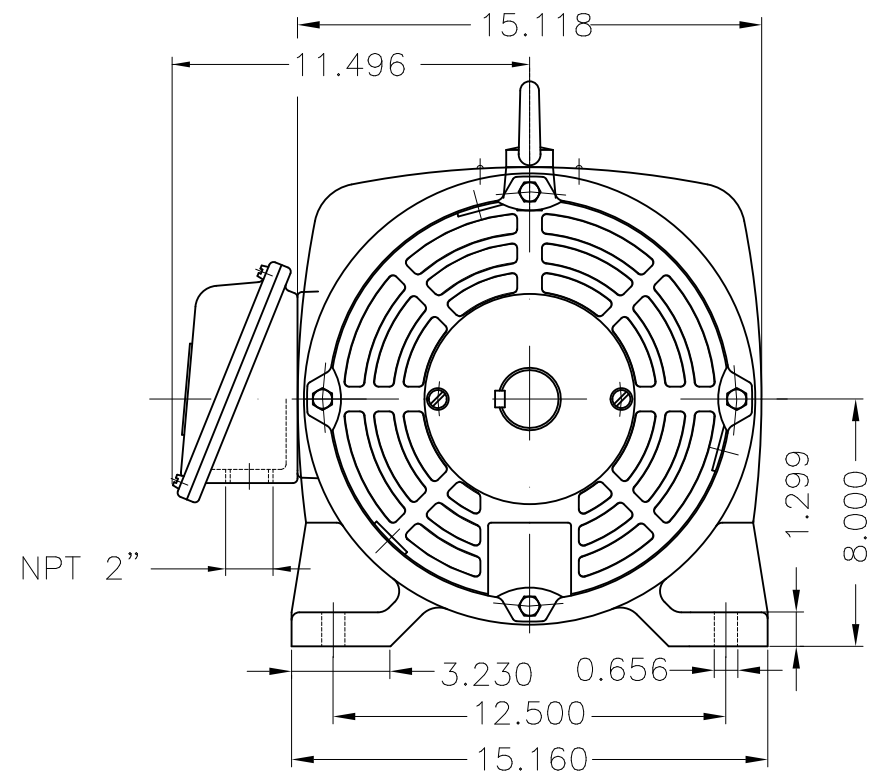

Color RAL 5009
Painting plan 203A
Mounting B3R(D)

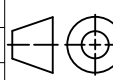
| ECM | LOC | SUMMARY OF MODIFICATIONS | EXECUTED | CHECKED | RELEASED | DATE | VER |
|----------|------------|--|---------------------|---------|----------|------|-----|
| EXECUTED | USERADMIN |  THREE PHASE NEMA P. EFF MOTOR FRAME 324T IP23 ODP WEG code: 11332119 | | | | | |
| CHECKED | | | | | | | |
| RELEASED | | | | | | | |
| REL DT | 24.07.2017 | WMO Jaragua do Sul | Product Engineering | SHEET | 1 / 1 | | |

25 HP 06 Poles 60Hz

A

