

Dimensões em polegada
Dimensions in inches

THIS IS AN UPDATED REVISION, THE
PREVIOUS ONE MUST BE DISREGARDED.

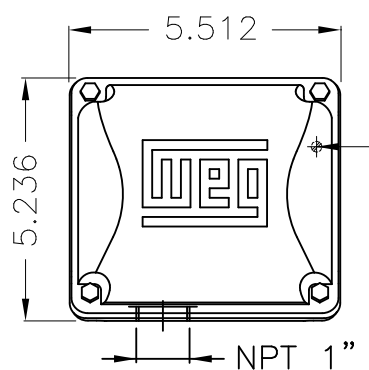

Main terminal box

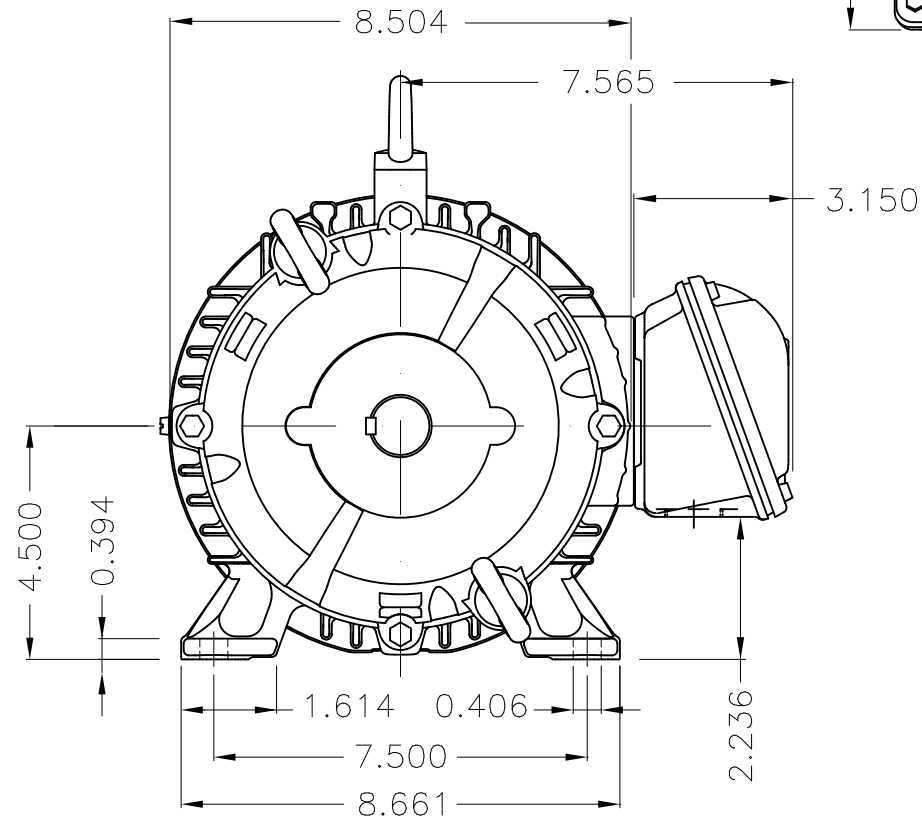
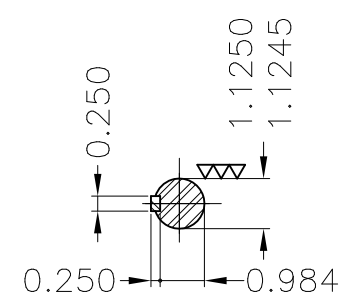
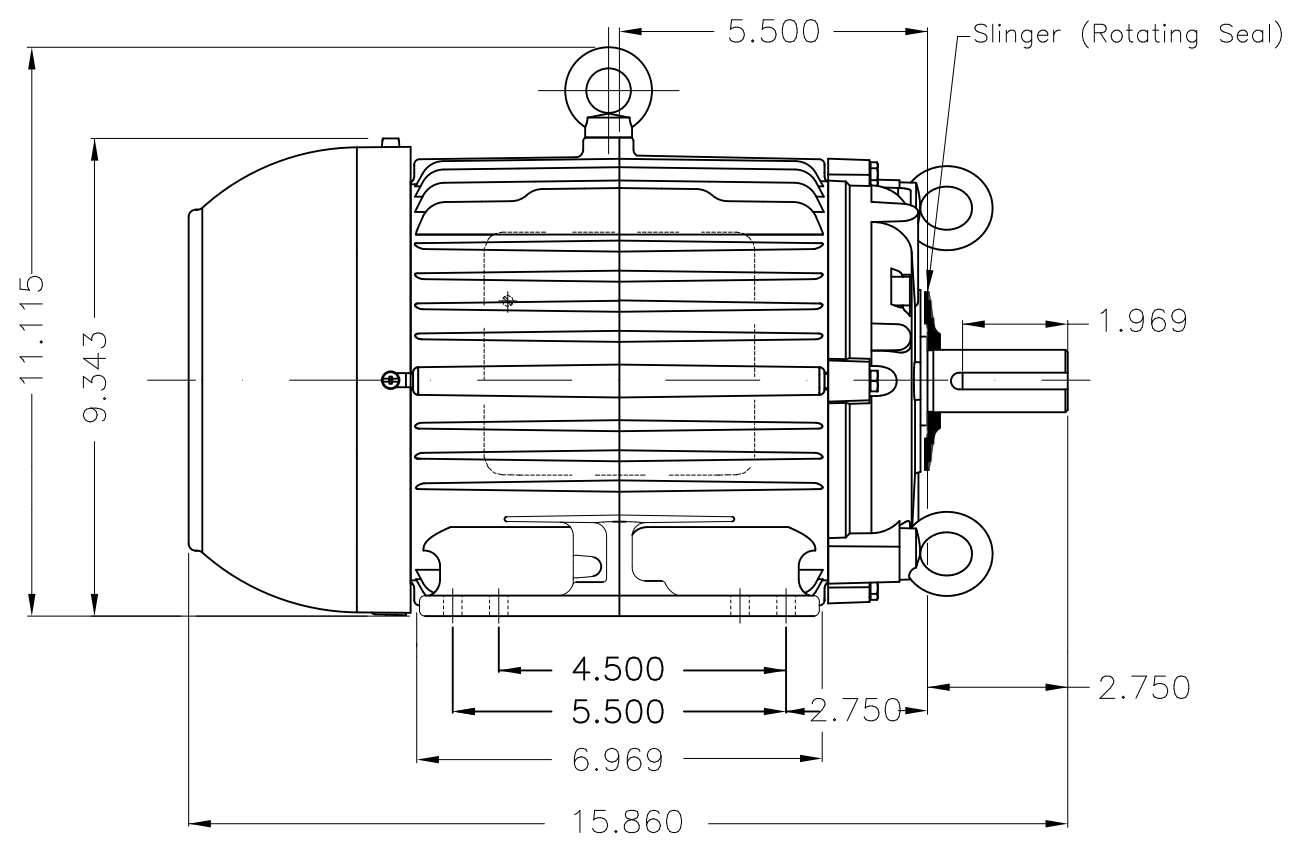

DE Shaft End

Color RAL 5009
Painting plan 202E
Mounting B3L(E)

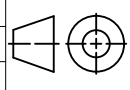
ECM	LOC	SUMMARY OF MODIFICATIONS			EXECUTED	CHECKED	RELEASED	DATE	VER
EXECUTED	USERADMIN		THREE PH W22 MOTOR COOLING TOWER NEMA EF						
CHECKED			FRAME 182/4T IP55 TEFC						
RELEASED			WEG code: 12024061						
REL DT	24.07.2017	WMO	Jaragua do Sul	Product Engineering	SHEET	1 / 1			

5 HP 04 Poles 60Hz

A

