

Dimensões em polegada
Dimensions in inches

THIS IS AN UPDATED REVISION, THE
PREVIOUS ONE MUST BE DISREGARDED.

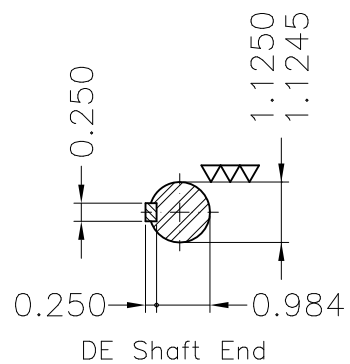
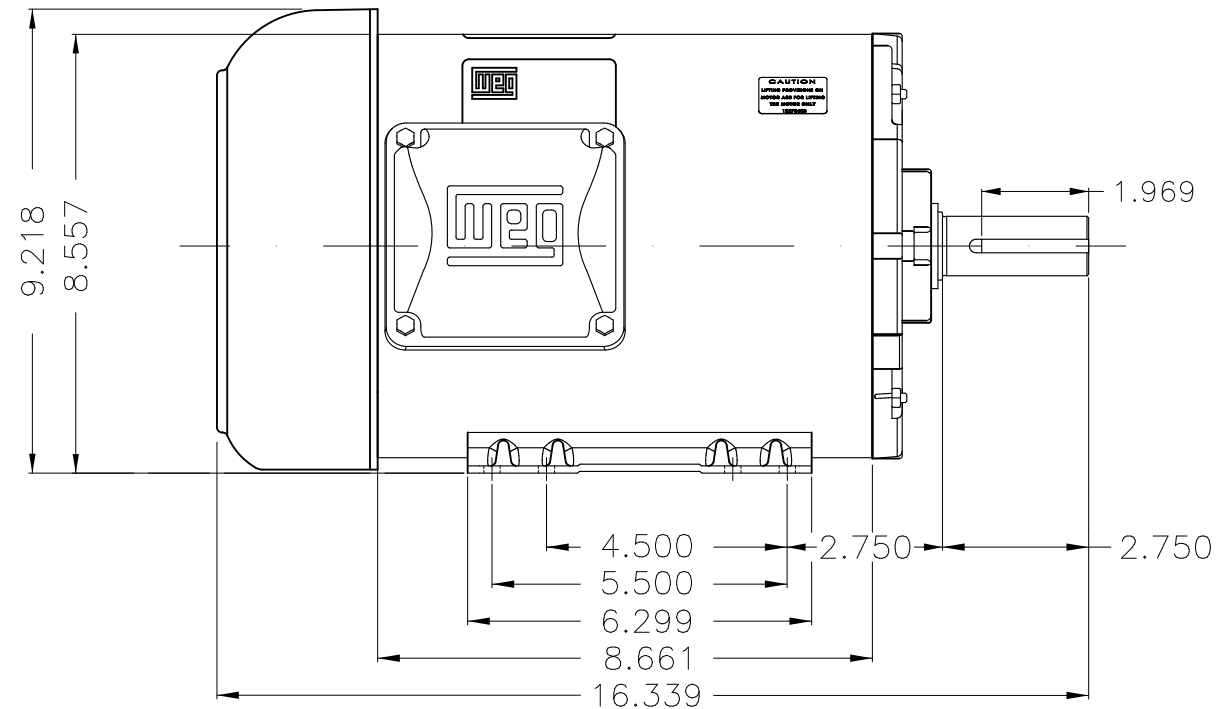
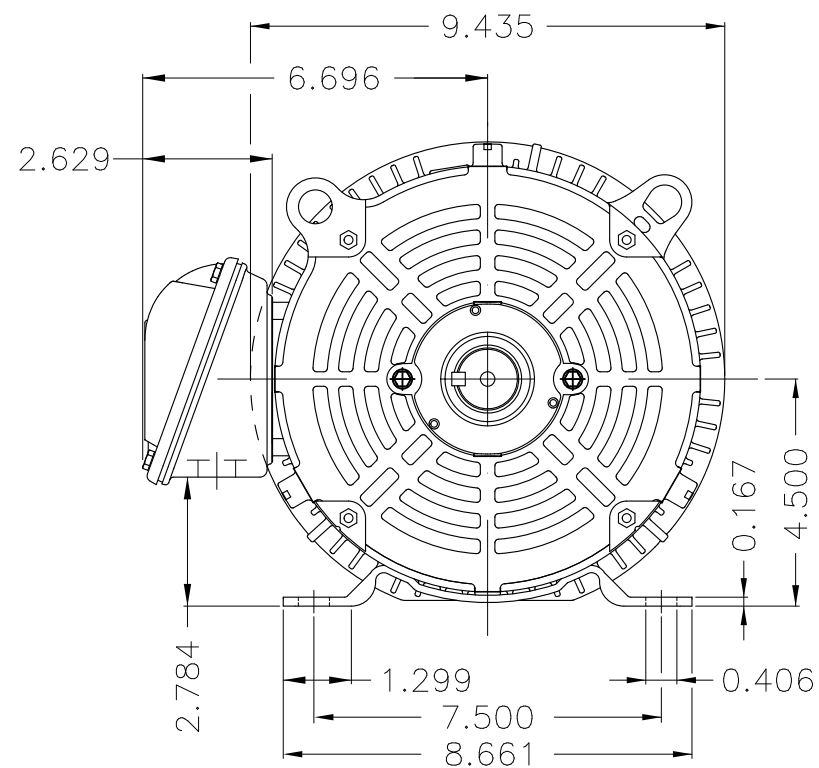
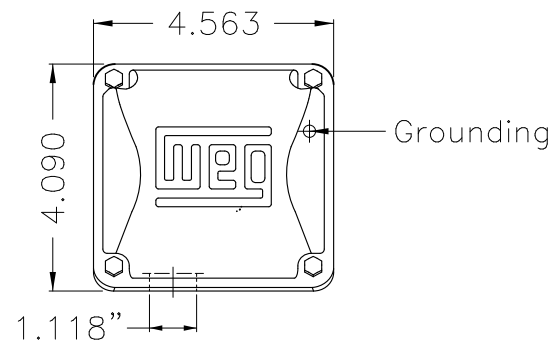

Brush holder Kit AEGIS internal DE
Bearing cap
Color Munsell N 1 matte black
Painting plan 207N
Mounting F-1/B3R(D)

ECM	LOC	SUMMARY OF MODIFICATIONS	EXECUTED	CHECKED	RELEASED	DATE	VER
EXECUTED	USERADMIN	THREE P. MOTOR TEFC ROLLED STEEL NEMA P. FRAME 182/4T IP55 TEFC WEG code: 12759356					
CHECKED							
RELEASED							
REL DT	24.07.2017	WMO Jaragua do Sul	Product Engineering	SHEET	1 / 1		

1.5 HP 06 Poles 60Hz

A



ZME A3